

**COMPARISON OF THE PERFORMANCE OF U.S. AND JAPANESE  
ALUMINUM BATS  
USING U.S. AND JAPANESE TEST PROTOCOLS**

BY

SHINTARO NABESHIMA  
B.S. Eng UNIVERSITY OF MASSACHUSETTS LOWELL (2001)

SUBMITTED IN PARTIAL FULLFILMENT OF THE REQUIREMENTS FOR THE  
DEGREE OF MASTER OF SCIENCE IN MECHANICAL ENGINEERING  
DEPARTMENT OF MECHANICAL ENGINEERING  
UNIVERSITY OF MASSACHUSETTS LOWELL

Signature of

Author: \_\_\_\_\_ Date: \_\_\_\_\_

Signature of Thesis

Supervisor: \_\_\_\_\_

Signatures of Other

Committee Members: \_\_\_\_\_

\_\_\_\_\_

**COMPARISON OF THE PERFORMANCE OF U.S. AND JAPANESE  
ALUMINUM BATS  
USING U.S. AND JAPANESE TEST PROTOCOLS**

BY

SHINTARO NABESHIMA

ABSTRACT OF A THESIS SUBMITTED TO THE FACULTY OF THE  
DEPARTMENT OF MECHANICAL ENGINEERING  
IN PARTIAL FULLFILMENT OF THE REQUIREMENTS FOR THE DEGREE OF  
MASTER OF SCIENCE IN MECHANICAL ENGINEERING  
DEPARTMENT OF MECHANICAL ENGINEERING  
UNIVERSITY OF MASSACHUSETTS LOWELL  
2004

Thesis Supervisor: James A Sherwood, Ph.D, P.E.  
Professor, Department of Mechanical Engineering

## ABSTRACT

In 1998, the National Collegiate Athletic Association (NCAA) took steps to develop a scientific test methodology to measure and to control aluminum baseball bat performance. The resulting standard uses a hitting machine that pitches a ball at a moving bat to measure the BESR (Ball Exit Speed Ratio). Concurrently, the governing body for amateur baseball in Japan developed a test protocol for controlling bat performance. In contrast to the NCAA test methodology, the Japanese protocol uses a series of static tests. This paper compares the two protocol philosophies, presents experimental data highlighting the respective criteria of each approach and discusses how successful each approach has been in controlling the performance of nonwood baseball bats. Comparison data and analysis showed that some Japanese bats marginally outperformed U.S. bats with respect to batted-ball speed. Despite the lack of direct restriction on batted-ball performance using a dynamic test method, the Japanese regulation is controlling the performance of aluminum bats fairly well.

## ACKNOWLEDGEMENTS

Prof. James Sherwood, for being not only my thesis advisor, but also an instructor for many of my courses for my undergraduate and graduate education at UMass Lowell.

Prof. Peter Avitabile and Prof. Sammy Shina, for taking time and providing precious feedback as my thesis committee.

Patrick Drane, for taking time to answer my questions, critique my writing thoroughly, and provide suggestion for improving my thesis.

Mr. Kenichi Tokieda and ZETT, for providing many of Japanese aluminum baseball bats and useful information about Japanese aluminum bat regulations.

Representatives from Hillerich and Bradsby (H&B) and Easton Sports, for providing U.S. aluminum bats and some of Japanese aluminum bats.

UMass Lowell Baseball Research Center crews, for helping me performing various tests.

UMass Lowell Composite Lab crews, for helping me performing various tests.

All my friends who have helped me.

My parents, Shinichi and Harumi Nabeshima, for allowing me to study in the U.S. and supporting me financially.

## NOTATIONS

### ***Variables Used***

$v$ :	Ball entry speed [mph]
$v_o$ :	Ball exit speed [mph]
$V$ :	Bat entry speed at the 6-inch point from the tip of the barrel of the bat [mph]
$I$ :	Mass moment of inertia (MOI) of the bat [oz-in <sup>2</sup> ]
$\tau$ :	Period of oscillation [s]
$d$ :	Distance from pivot to the knob end of the bat [in]
$L$ :	Length of the bat [in]
$L_{cg}$ :	Distance from the tip of the barrel to the center of gravity [in]
$m$ :	Mass of the bat [oz]
$m_{fix}$ :	Mass of the fixture [oz]
$g$ :	Acceleration due to gravity [in/s <sup>2</sup> ]
$V_{bestr}$ :	Raw BESR based performance [mph]
$V_{bestr\_norm}$ :	BESR based performance after normalization [mph]
$V_{R30}$ :	Exit speed of R30a lot ball obtained from the ball certification [mph]
$V_{Rxx}$ :	Exit speed of Rxx lot ball obtained from the ball certification [mph]
$OL$ :	Corrected offset load [N]
$OL_{original}$ :	Original offset load value obtained from the graph [N]
$L_{ring}$ :	Length of the ring [mm]
$\Delta V_i$ :	Change in swing speed at 6-in location due to MOI [mph]
$v'_b$ :	Batted-ball velocity [mph]
$V$ :	Original bat swing speed [mph]
$v$ :	Ball entry speed [mph]
$t_{real}$ :	Real wall thicknesses of the bat [in]
$t_{ultrasonic}$ :	Wall thicknesses of the bat obtained with the ultrasonic gage [in]
$t_{ring\_caliper}$ :	Wall thickness of the ring obtained with the dial caliper [in]
$t_{ring\_ultrasonic}$ :	Wall thickness of the ring obtained with the ultrasonic gage [in]

$V_{ring}$ :	Volume of the ring [in <sup>3</sup> ]
$D_1$ :	Outer diameter of the ring on one side [in]
$d_1$ :	Inner diameter of the ring on the same side as $D_1$ [in]
$D_2$ :	Outer diameter of the ring on the other side from $D_1$ [in]
$d_2$ :	Outer diameter of the ring on the same side as $D_2$ [in]
$D_o$ :	Maximum original outer diameter of the ring [in]
$h$ :	Length of the ring [in]

### ***Acronyms***

NCAA:	The National Collegiate Athletic Association
BESR:	The Ball Exit Speed Ratio
JHBF:	The Japan High School Baseball Federation
CPSA:	The Consumer Product Safety Association in Japan
IBAF:	The International Baseball Federation
JABA:	The Japan Amateur Baseball Association
MOI:	Mass moment of inertia
SG:	Safety standards of consumer products established by CPSA (S denotes “safety”, G denotes “goods”)
BHM:	The Baum Hitting Machine
OD:	Outer diameter
ID:	Inner diameter
COP:	Center of percussion
FRF:	The frequency response function
Sweet Spot:	The highest performing impact position on a bat

## TABLE OF CONTENTS

<b>ABSTRACT</b> .....	<b>IV</b>
<b>ACKNOWLEDGEMENTS</b> .....	<b>V</b>
<b>NOTATIONS</b> .....	<b>VI</b>
<b>TABLE OF CONTENTS</b> .....	<b>VIII</b>
<b>LIST OF FIGURES</b> .....	<b>XI</b>
<b>LIST OF TABLES</b> .....	<b>XIII</b>
<b>1 INTRODUCTION</b> .....	<b>1</b>
1.1 MOTIVATION.....	5
1.2 SCOPE .....	6
<b>2 BACKGROUND</b> .....	<b>7</b>
2.1 THE U.S. REGULATIONS AND PROTOCOLS .....	8
2.1.1 <i>BESR</i> .....	8
2.1.2 <i>The -3 Rule</i> .....	9
2.1.3 <i>Maximum Barrel Diameter Restriction</i> .....	9
2.1.4 <i>Minimum Moment of Inertia (MOI) Restriction</i> .....	10
2.2 JAPANESE REGULATIONS AND PROTOCOLS .....	12
2.2.1 <i>Three-Point Bending Test</i> .....	12
2.2.2 <i>Wedge Test</i> .....	13
2.2.3 <i>Barrel Compression Test (Flattening Test of the Batting Point)</i> .....	13
2.2.4 <i>Minimum Weight Restriction</i> .....	14
2.2.5 <i>Maximum Diameter Restriction</i> .....	15
2.2.6 <i>Shape Requirement</i> .....	15
2.2.7 <i>Cap Test</i> .....	16
2.2.8 <i>Grip End Test</i> .....	18
2.2.9 <i>Sound Test</i> .....	19
<b>3 METHODOLOGY</b> .....	<b>20</b>
3.1 BESR PROTOCOL.....	20

3.1.1	<i>Preparation for the Test</i> .....	20
3.1.2	<i>Performance Test by BHM</i> .....	24
3.1.3	<i>Adjustment Prior to Comparison</i> .....	26
3.2	SG STANDARD BASED TEST (BARREL COMPRESSION TEST) .....	27
3.3	MOI COMPARISON.....	30
3.4	WALL THICKNESS MEASUREMENT AND PARTIAL WEIGHT COMPARISON .....	32
3.5	MODAL TESTS AND CENTER OF PERCUSSION (COP) COMPARISON .....	36
<b>4</b>	<b>RESULTS / DISCUSSION</b> .....	<b>40</b>
4.1	BESR PERFORMANCE DATA.....	41
4.1.1	<i>BESR Performance for Japanese Bats</i> .....	41
4.1.2	<i>BESR Performance for U.S. Bats</i> .....	50
4.1.3	<i>Overall BESR Performance Comparison Results</i> .....	53
4.2	BARREL COMPRESSION TEST DATA.....	56
4.2.1	<i>Offset Loads for Japanese Bats</i> .....	56
4.2.2	<i>Offset Loads for U.S. Bats</i> .....	58
4.2.3	<i>Overall Offset Load Comparison Results</i> .....	58
4.3	WALL THICKNESS MEASUREMENTS .....	60
4.3.1	<i>Wall Thickness of Japanese Bats</i> .....	60
4.3.2	<i>Wall Thickness of U.S. Bats</i> .....	68
4.3.3	<i>Overall Wall Thickness Comparison Results</i> .....	71
4.4	MODAL TEST RESULTS AND CENTER OF PERCUSSION (COP) .....	72
4.4.1	<i>Node Points and COPs of Japanese Bats</i> .....	73
4.4.2	<i>Node Points and COPs of U.S. Bats</i> .....	81
4.4.3	<i>Overall Node Points and COP Comparison Results</i> .....	84
4.5	MASS MOMENT OF INERTIA (MOI) COMPARISON.....	85
4.6	PARTIAL WEIGHT COMPARISON .....	87
4.6.1	<i>Partial Weight Comparison by Ring Weight</i> .....	90
4.6.2	<i>Partial Weight Comparison by Cumulative Weight</i> .....	92
4.6.3	<i>Partial Weight Comparison Results</i> .....	94
4.7	OVERALL COMPARISON CONCLUSION .....	94
<b>5</b>	<b>CONCLUSIONS</b> .....	<b>95</b>
<b>6</b>	<b>RECOMMENDATIONS</b> .....	<b>96</b>
<b>7</b>	<b>LITERATURE CITED</b> .....	<b>98</b>
	<b>APPENDIX A</b> .....	<b>A-1</b>



<b>APPENDIX B.....</b>	<b>B-1</b>
<b>APPENDIX C.....</b>	<b>C-1</b>

## LIST OF FIGURES

FIG. 1: THREE-POINT BENDING TEST CONFIGURATION.....	12
FIG. 2: WEDGE TEST CONFIGURATION.....	13
FIG. 3: OFFSET LOAD FROM LOAD -VS.- DEFLECTION CURVE.....	14
FIG. 4: CAP PULL TEST CONFIGURATION.....	17
FIG. 5: CAP PUSH TEST CONFIGURATION .....	17
FIG. 6: GRIP END TEST CONFIGURATION.....	18
FIG. 7: SOUND TEST CONFIGURATIONS.....	19
FIG. 8: MEASURING THE DIAMETER OF A BAT.....	22
FIG. 9: A BAT IN PENDULUM FIXTURE.....	23
FIG. 10: MEASURING THE DISTANCE FROM PIVOT TO KNOB END .....	23
FIG. 11: ACTUAL PICTURE OF THE TARGET (DRANE 2003).....	25
FIG. 12: CRITERIA FOR TARGETING (DRANE 2003) .....	25
FIG. 13: THREE RINGS TAKEN FROM THE BARREL OF A BAT.....	27
FIG. 14: A RING ON AN ADJUSTABLE BASE FOR COMPRESSION TEST .....	29
FIG. 15: WALL-THICKNESS MEASUREMENTS WITH THE ULTRASONIC THICKNESS GAGE .....	32
FIG. 16: FIVE LOCATIONS AT EACH POSITION FOR WALL THICKNESS MEASUREMENT .....	33
FIG. 17: TAKING OUT AN IMAGINARY RING OF A BAT .....	35
FIG. 18: ACCELEROMETER ATTACHED TO THE BARREL OF THE BAT .....	36
FIG. 19: IMPACTING A BAT WITH AN IMPACT HAMMER.....	37
FIG. 20: FRF DISPLAYED ON ANALYZER.....	37
FIG. 21: FRF WHEN THE FIRST NODE WAS IMPACTED .....	38
FIG. 22: BATTED-BALL PERFORMANCE DATA FOR SN01 .....	42
FIG. 23: BATTED-BALL PERFORMANCE DATA FOR SN02 .....	43
FIG. 24: BATTED-BALL PERFORMANCE DATA FOR SN03 .....	44
FIG. 25: BATTED-BALL PERFORMANCE DATA FOR SN04 .....	45
FIG. 26: BATTED-BALL PERFORMANCE DATA FOR SN05 .....	47
FIG. 27: BATTED-BALL PERFORMANCE DATA FOR SN06.....	48
FIG. 28: BATTED-BALL PERFORMANCE DATA FOR SN10.....	49
FIG. 29: BATTED-BALL PERFORMANCE DATA FOR SN11 .....	50
FIG. 30: BATTED-BALL PERFORMANCE DATA FOR SN07 .....	51
FIG. 31: BATTED-BALL PERFORMANCE DATA FOR SN08.....	52

FIG. 32: BATTED-BALL PERFORMANCE DATA FOR SN09 .....	53
FIG. 33: COMPARISON IN PERFORMANCE AVERAGE OF U.S. AND JAPANESE BATS .....	54
FIG. 34: PERFORMANCE DISTRIBUTION BY OFFSET LOAD AND BALL EXIT SPEED .....	59
FIG. 35: WALL-THICKNESS DISTRIBUTION OF SN01 .....	61
FIG. 36: WALL-THICKNESS DISTRIBUTION OF SN02 .....	62
FIG. 37: WALL-THICKNESS DISTRIBUTION OF SN03 .....	63
FIG. 38: WALL-THICKNESS DISTRIBUTION OF SN04 .....	64
FIG. 39: WALL-THICKNESS DISTRIBUTION OF SN05 .....	65
FIG. 40: WALL-THICKNESS DISTRIBUTION OF SN06 .....	66
FIG. 41: WALL-THICKNESS DISTRIBUTION OF SN10 .....	67
FIG. 42: WALL-THICKNESS DISTRIBUTION OF SN11 .....	68
FIG. 43: WALL-THICKNESS DISTRIBUTION OF SN07 .....	69
FIG. 44: WALL-THICKNESS DISTRIBUTION OF SN08 .....	70
FIG. 45: WALL-THICKNESS DISTRIBUTION OF SN09 .....	70
FIG. 46: NODE POINTS AND COP OF SN01 .....	74
FIG. 47: NODE POINTS AND COP OF SN02 .....	75
FIG. 48: NODE POINTS AND COP OF SN03 .....	76
FIG. 49: NODE POINTS AND COP OF SN04 .....	77
FIG. 50: NODE POINTS AND COP OF SN05 .....	78
FIG. 51: NODE POINTS AND COP OF SN06 .....	79
FIG. 52: NODE POINTS AND COP OF SN10 .....	80
FIG. 53: NODE POINTS AND COP OF SN11 .....	81
FIG. 54: NODE POINTS AND COP OF SN07 .....	82
FIG. 55: NODE POINTS AND COP OF SN08 .....	83
FIG. 56: NODE POINTS AND COP OF SN09 .....	84
FIG. 57: RELATIONSHIP BETWEEN PERFORMANCE AND MOI WITH MOI NORMALIZATION. 87	
FIG. 58: DEFINITION OF “CUMULATIVE WEIGHT UP TO 6-INCH POSITION” .....	88
FIG. 59: BARREL TIPS WITH END CAPS .....	89
FIG. 60: COMPARISON OF RING WEIGHT DISTRIBUTION ABOUT POSITIONS ON BATS .....	91
FIG. 61: CUMULATIVE WEIGHT DISTRIBUTION COMPARISON FOR SN01 AND SN08.....	92
FIG. 62: CUMULATIVE WEIGHT DISTRIBUTION ABOUT POSITIONS ON BAT .....	93

## LIST OF TABLES

TABLE 1: NCAA MINIMUM MOI (SHERWOOD 2000).....	11
TABLE 2 : BAT IDENTIFICATION FOR THIS THESIS.....	40
TABLE 3 : INFORMATION ABOUT THE BASEBALL LOTS USED FOR PERFORMANCE TEST .....	41
TABLE 4: MAXIMUM PERFORMANCE OF THE BATS .....	55
TABLE 5: OFFSET LOADS OF RINGS OF JAPANESE BATS .....	57
TABLE 6: OFFSET LOADS OF RINGS OF U.S. BATS .....	58
TABLE 7: NODE POINT POSITIONS FROM TIP OF BARREL FOR FIRST TWO MODES .....	72
TABLE 8: COP POSITIONS FROM TIP OF BARREL OF BAT .....	73
TABLE 9 : MOI OF THE BATS.....	85
TABLE 10: WEIGHT OF FIRST 3-INCHES OF THE BATS .....	89

## 1 INTRODUCTION

Baseball originated in the early 19th century in the U.S. In the beginning, the majority of baseball bats were made of wood. Wood was an ideal material for making bats because of its availability and the ease of manufacturing. However, from a batter's perspective, wood bats are not always the ideal material choice due to an inevitable fact; wood bats often break. Because of this fact, baseball players and teams have been hurt financially by wood bats and even physically due to broken bats. Because wood bats are not necessarily durable, teams are forced to have many bats on-hand, and the expense for purchasing bats is not insignificant. In 1970, a possible solution to reduce the cost associated with bats appeared: the introduction of aluminum bats.

One advantage of an aluminum bat is its durability. The durability of wood bats is inconsistent. Some wood bats break after a single impact while others may last several hundreds of hits. However, aluminum bats usually do not break even after thousands of hits. An aluminum bat can be more expensive than a wood bat, but an aluminum bat generally lasts considerably longer than a wood bat. This fact demonstrates that baseball teams can reduce costs for purchasing bats by replacing wood bats with aluminum bats. Considering this cost advantage, the National Collegiate Athletic Association (NCAA) allowed the usage of aluminum bats in its baseball games starting in 1974.

In the same year as the NCAA's decision, the Japan High School Baseball Federation (JHBF) in Japan, where baseball was brought from the U.S. in 1873 (The

Baseball Hall of Fame 2003), allowed the usage of aluminum bats in its baseball games. Like the NCAA, the decision was made due to economical reasons, but the situation in Japan required the JHBF to take the action immediately. After the first Oil Crisis in 1973, the price of wood rose suddenly due to the increase in manufacturing cost, and bat manufacturers were forced to increase the price of wood bats. It was obvious that the increase in wood-bat prices was very critical for high school baseball teams whose budgets were limited in comparison to those of the professional teams. Though the economic issue was solved by introducing metal bats, baseball teams encountered another potential problem that was not prominent in the usage of wood bats; a threat to the safety of baseball players due to high ball exit speeds.

When metal bats first became available, the performance of metal bats was similar to that of wood bats. However, as the technologies around metal bats advanced, the performance of metal bats improved dramatically. The improvement in performance of metal bats translated to the increase in the ball exit speed. When the ball exit speed increases, the dynamic energy the ball gains increases. Likewise, the time given to a player, who is almost hit by the ball, to protect himself or herself decreases. In short, the potential to injure a player increases when a ball is hit by a high-performance metal bat in comparison to a wood bat. This tendency was seen in both of the countries and is not negligible considering the probability of injuries due to the batted ball. According to Little League Baseball injury data presented by Dr. Creighton Hale to the American Academy of Orthopaedic Surgeons in 1967, the batted ball is the cause of 30% of head injuries in Little League (Hutchens 1998).

In 1986, the Ministry of International Trade and Industry of Japan, which is the competent authority of the Consumer Product Safety Association (CPSA), revised the safety standard of aluminum bats and required the bats to pass three more tests in addition to grip end test to be discussed in Section 2.2.8, which was introduced in 1975. The three tests were the three-point bending test, wedge test, and barrel-compression test (flattening test). This revision was made primarily to prevent manufacturers from making aluminum bats with poor durability (JHBF 2003). In the mid 1980s, bat manufactures produced many aluminum bats with large-diameter barrels and with thin-walled tapers because such designs give the bats resilience and make the bats perform better than aluminum bats with small-diameter barrels. However, at the same time, the aluminum bats with such design features tend to induce very high stress at the taper on impact and tend to break at the taper (Ohnishi 1997). The spots on an aluminum bat where the three-point bending test and the wedge test are to be performed were determined by referring to the breakage points of bats in the field. The barrel compression test was introduced to regulate resiliency, which is one of the factors that determine the hitting performance of aluminum bats, and to investigate if the barrel of the bat cracks under an excessive amount of force and displacement.

The revised standard reduced the potential for the breaking of aluminum bats, but pitchers were still in potential danger of being hit by batted balls and being severely injured. Though the concern about the safety of pitchers was mounting, the JHBF was unable to introduce a tighter regulation for restricting aluminum bat dimensions after their proposal of the regulation was rejected by the International Baseball Federation (IBAF), which is the governing body of international baseball games such as Olympic

baseball games (Ohtsubo 1999). As of April 2003, seven deaths of pitchers due to being hit by batted balls were reported to the JHBF since the introduction of aluminum bats in Japan to high school baseball leagues in 1974 ("A Pitcher Was Killed" 2003).

Though the injuries and the deaths of pitchers were the most noticeable concern associated with the use of high-performance aluminum bats, there was another "side effect": an obvious advantage of offense over defense. The introduction of high-performance aluminum bats allows the offense to score more runs than when wood bats are used primarily because of the greater number of homeruns. For example, in NCAA Division I baseball games, the average scoring per game for each team was 5.07 in 1973, when only wood bats were used. However, the scoring went up to 5.33 as soon as aluminum bats were introduced in 1974, and the scoring in 1998 was 7.12 (NCAA 2003). The strong offense makes for a long baseball game and upsets the balance between offense and defense.

The simplest solution for solving the problems associated with aluminum bats is to replace aluminum bats with wood bats. This solution was implemented by some groups. In 2001, the Japan Amateur Baseball Association (JABA) was determined to ban aluminum baseball bats in their company league baseball games, and the decision took effect in the 2002 season. In 2003, the state of Massachusetts banned aluminum baseball bats in the state high school baseball tournament. However, it is obvious that such a solution is costly for baseball teams. For instance, after the JABA's reintroduction of wood bats, the cost for baseball bats for one company league baseball team increased fourfold (Kinkai 2002).



Considering the respective advantages of aluminum bats and wood bats, the ideal solution is to introduce aluminum bats that perform like wood bats. In September 1999, the NCAA introduced a new protocol to regulate the performance of aluminum bats in addition to the -3 unit difference rule, which will be discussed in Section 2.1.2, and the 2 5/8-in barrel rule, which were introduced in January 1999. The protocol was established to reduce the manufacturers' ability to sell bats which perform significantly better than wood bats. Then, the -3 unit difference rule made the weight of aluminum bats similar to wood bats, so the swing speeds of aluminum bats, which are one of the elements determining batted-ball speed, would be close to that of wood bats.

After the NCAA's 1999 introduction of the new standard, in 2001, the Japan Official Baseball Playing Rules Committee decided to add a rule to set the maximum allowable outer diameter and the minimum allowable weight of aluminum bats ("Rule Revision"). This action was taken to limit a bat makers' ability to design and manufacture high-performance aluminum bats. However, there is no regulation or test methodology which directly restricts the batted-ball performance of aluminum bats yet in Japan.

## 1.1 Motivation

The motivation for performing the comparison of Japanese aluminum baseball bats and American aluminum baseball bats was driven by the difference in regulations between the two countries to restrict the performance of aluminum bats. While the U.S. took the direct method which limited the bat manufacturers' potential of providing high-performance aluminum bats to the official games, Japan took the indirect method which gave constraints from designing high-performance aluminum bats. Therefore, the

comparison study will provide an opportunity to investigate if each protocol successfully restricts the aluminum bats' performance to the acceptable level, which usually means the typical performance of wood bats. The differences in the regulations cause aluminum bats to be designed differently, which may cause the performance difference to exist. This thesis will provide insight to determine which aspects of aluminum bats should be regulated if no direct approach of measuring batted-ball speed is employed to regulate the performance of aluminum bats. Minor tests such as modal tests, wall thickness measurements, MOI comparison, and partial weight measurements were also performed to explore if there exists any correlation with these differences and performance.

## 1.2 Scope

This thesis will compare the batted-ball performance of American aluminum baseball bats compliant to the NCAA standard against Japanese aluminum baseball bats for general players compliant to the SG standard. To support the performance test results, various factors such as MOI, wall thicknesses, mass distributions, and modal node points, which may affect the performance of those bats, are examined. To obtain the BESR, a measure of bat performance on the Baum Hitting Machine (BHM), which is the machine used for baseball bat certification for the NCAA, is utilized. The barrel compression test is performed on each bat with an Instron machine by following the SG protocol established by the CPSSA.

## 2 BACKGROUND

It is important that the differences in the aluminum bat regulations between the U.S. and Japan are identified and are clarified to examine and compare the batted-ball performances of aluminum bats sold in the two countries that are designed to satisfy the respective protocols. In this chapter, the rules and protocols employed to regulate the performance of aluminum bats in both countries are explained. In this thesis, the NCAA compliant aluminum bats were chosen for the U.S. bats, and the SG compliant aluminum bats for general players, which are defined as high school students or older players, were chosen for the Japanese bats. The NCAA is not the only governing body for baseball games and goods used in games in the U.S. The reason why the NCAA compliant bats were selected as the representative U.S. bats was because some of the Japanese protocols were intended only for the bats for general players. Therefore, it was concluded that it was appropriate to choose the NCAA compliant bats for comparing to the SG compliant bats for general players.

## 2.1 The U.S. Regulations and Protocols

To make an aluminum bat legal for use in NCAA games, the bat must satisfy four criteria.

### 2.1.1 BESR

BESR denotes the **B**all **E**xit **S**peed **R**atio and was a new parameter established by the NCAA in 1999 to describe the performance of baseball bats. The *BESR* is calculated by substituting three speeds in a hitting process, which are the ball entry speed, the ball exit speed, and the bat entry speed, and are obtained from the Baum Hitting Machine (BHM) for NCAA certification, into the Eq. 1:

$$BESR = \frac{[v_o - \frac{V - v}{2}]}{V + v} \quad \text{Eq. 1}$$

where:  $v$  is the ball entry speed

$v_o$  is the ball exit speed

$V$  is the bat entry speed at the 6-inch point from the tip of the barrel of the bat

The BESRs of aluminum bats used in NCAA games cannot exceed specified BESR limits for the bats to be certified. The BESR limit is a function of the “liveliness” of the lot of balls used for the bat certification tests, and the BESR limit for a given lot of baseballs is determined by the results of ball certification tests, which are performed on the BHM with a 34-in Baum AAA Pro bat. When performing bat performance tests on the BHM, the pitch speed must be  $70 \pm 2$  mph, and the swing speed at the 6-inch point (from the tip of the barrel) must be  $66 \pm 1$  mph.

In the usual BESR certification tests, an average of five valid hits at the point of maximum exit velocity is used to determine whether or not the bat performs within the acceptable BESR range. Therefore, if the performance of a bat as concluded from the average of five valid hits exceeds the BESR limit at any location during the progression of the certification process, the bat fails the certification test and the testing in the BHM is terminated without investigating the performance at any other locations on the bat. However, for this study, five valid hits for all five typical certification positions were taken for all bats used in this study regardless of pass or fail because the primary purpose of this thesis is the comparison of performance of the bat—not certification of the bat.

### 2.1.2 The -3 Rule

The definition of the -3 rule is that the length of a bat in inches must be no more than three units more than the weight (without the grip) of the bat in ounces. For example, if the length of a bat is 33.025 inches, its weight should not be less than 30.025 ounces. As mentioned in the Introduction chapter, this rule was established in January 1999 to prevent bat manufacturers from introducing extremely light aluminum bats to the NCAA competitions, and the weight of the aluminum bats will be close to that of typical wooden bats.

### 2.1.3 Maximum Barrel Diameter Restriction

The maximum allowable diameter of a bat, which usually means the barrel diameter, is 2.625 inches. This rule was added in January 1999 to prevent bat manufacturers from producing aluminum bats with a large diameter and restricts the size of the aluminum barrels to be comparable to those of wood, which are typically

2.5 inches or less. The barrel diameter may become out of round during the certification process due to plastic deformation of the aluminum. However, the maximum barrel diameter must be less than 2.625 inches anytime during and after the tests, and this criterion is checked using a bat ring with a 2.657-in ID. This criterion is used to rule out any bats of low durability and the potential for a deformed bat to hit faster than allowed by the BESR standard.

#### 2.1.4 Minimum Moment of Inertia (MOI) Restriction

The restriction in the moment of inertia of bats was established in 2002 in addition to the BESR-limit, maximum-barrel-OD and the -3 rules. The purpose of this rule is to prevent bat manufacturers from making bats of extremely low MOI. This rule was established because as MOI decreases, the ease of swinging increases. The increase in the ease of swinging the bat translates to an increase in swing speed, and the increase in swing speed translates to the increase in the exit velocity of a batted ball. Therefore, the restriction in the MOI of bats can reduce the possibility of an increase in the exit velocity of batted balls hit by strong batters with the bats that satisfy the BESR restriction in the BHM test. The list of minimum allowable MOI values is shown on Table 1.

**Table 1: NCAA Minimum MOI (Sherwood 2000)**

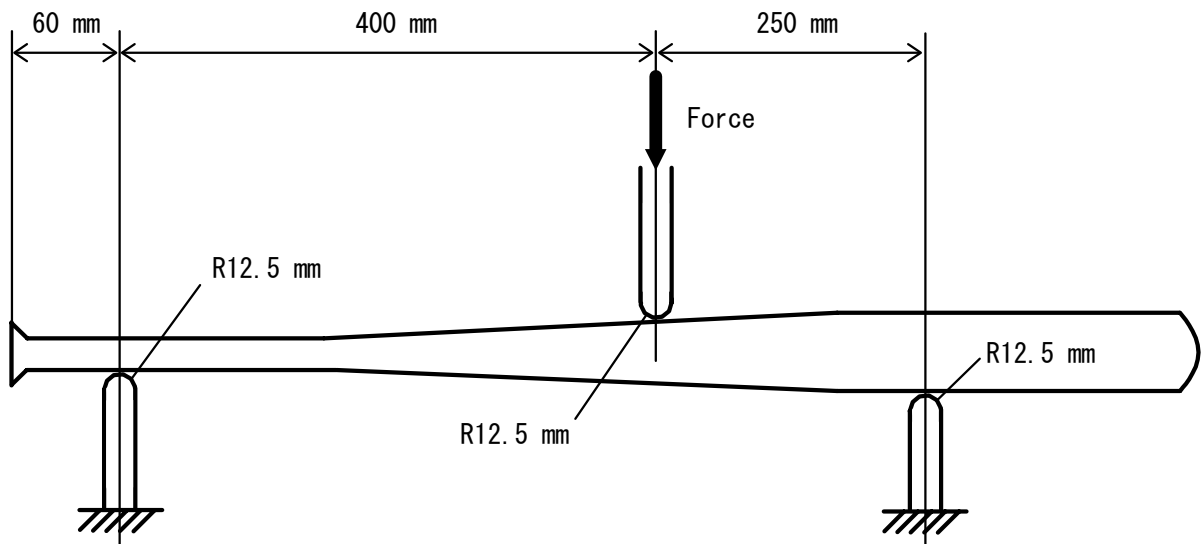
Bat Length (in)	Minimum Allowable MOI as measured at 6 inches from the knob (oz-in <sup>2</sup> )
29.0	5656
29.5	5966
30.0	6297
30.5	6649
31.0	7023
31.5	7418
32.0	7834
32.5	8271
33.0	8729
33.5	9209
34.0	9710
34.5	10232
35.0	10775
35.5	11339
36.0	11925

## 2.2 Japanese Regulations and Protocols

For the Japanese market, bat manufacturers must design and manufacture aluminum bats to satisfy seven criteria as established by the Consumer Product Safety Association (CPSA) for the SG (where S denotes “Safety”, and G denotes “Goods”) standard.

### 2.2.1 Three-Point Bending Test

The three-point bending test is performed to investigate the strength of the bats. For the bats to pass this test, the residual displacement of the bat should not exceed 2 mm when a 6500 N (1461 lb force) force, in the case of aluminum baseball bats for general players, is applied as shown in Fig. 1. In the SG standard, the “general players” are defined as high school students or older players. The location of applying the force was determined by referring to the breakage points of bats in the field.

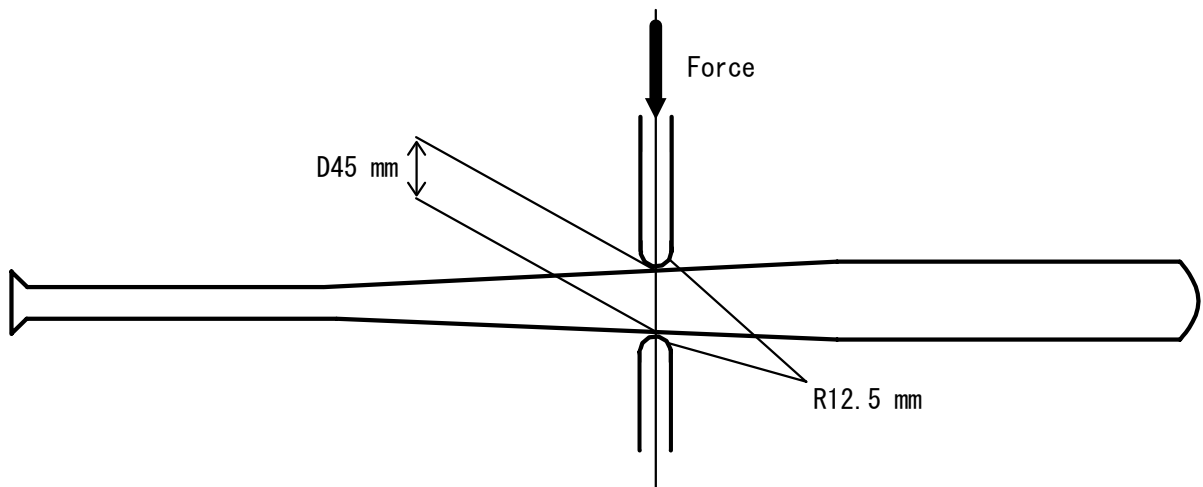


**Fig. 1: Three-point bending test configuration**



### 2.2.2 Wedge Test

The wedge test is performed to investigate the durability of the taper of bats. For the bats to pass this test, the residual displacement of the taper should not exceed 1 mm when a certain amount of force, which is 6000 N (1349 lb force) for aluminum baseball bats for general players, is applied at the point where the outer diameter of the bat is 45 mm as shown in Fig. 2.

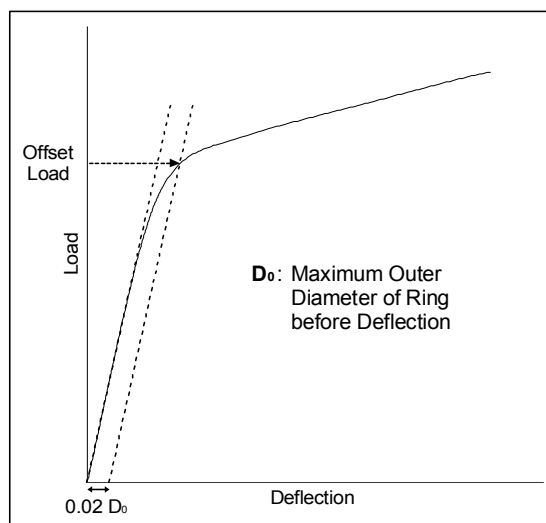


**Fig. 2: Wedge test configuration**

### 2.2.3 Barrel Compression Test (Flattening Test of the Batting Point)

The purpose of the barrel compression test is to investigate the durability and the resiliency of the barrel of a metal bat. To perform this test, the barrel of a bat is cut into three 50-mm long rings. Then, a force is applied on the ring until the deformation of the ring reaches  $0.2D_o$ , where  $D_o$  is the maximum original outer diameter of the ring, and until the applied force reaches 10,000 N. When the ring breaks without reaching  $0.2D_o$  deformation and 10,000 N applied force, the bat is considered to fail the test. From the load-deflection curve obtained from this test, the load corresponding to a residual

deformation of  $0.02D_0$ , which is called “offset load” in this thesis, is found (Fig. 3). For an aluminum baseball bat for general players, the offset load must be equal to or greater than 7500 N to pass the SG standard.



**Fig. 3: Offset load from Load -vs.- Deflection curve**

#### 2.2.4 Minimum Weight Restriction

The minimum weight restriction is one of the three new rules that were added in 2001 and applies only to aluminum baseball bats for general players. The other two rules are the maximum diameter restriction and the shape requirement, which will be discussed below. The total weight of a metal bat (with grip) must not be less than 900 g (31.75 oz) to meet the SG standard. The weight without the head cap, the grip-end knob, and grips must be  $810 \pm 10$  g ( $28.6 \pm 0.353$  oz) or more. Unlike the -3 rule of the NCAA, there is no length to weight ratio restriction in the standard. The purpose of the weight restriction is to reduce the swing speed. The decrease in the swing speed translates to the decrease in the performance. Before this restriction was established, the average weight of a metal

bat in Japan was about 800 g. According to the experiments performed by the Japan High School Baseball Federation (JHBF), a 100-g increase in the metal bat weight could reduce the swing speed by 3 km/h (1.86 mph) and decrease the batted-ball distance by 10 m (32.8 feet) ("Rule Revision" 2001).

#### 2.2.5 Maximum Diameter Restriction

The maximum allowable diameter of a metal bat is 67 mm (2.625 in). The maximum diameter, which usually means the diameter of a bat at its barrel, is restricted because bat manufacturers tended to design metal bats with large-diameter barrels. The large-diameter barrel generally deforms more than the barrel of relatively small diameter on impact and transfers more dynamic energy to the batted ball after the impact and reduces the deformation of the baseball than a small-diameter barrel. Thus, large-diameter metal bats would perform better than metal bats with relatively small diameters. Also, as the barrel diameter increases, the probability of hitting baseballs increases due to the increased hitting area.

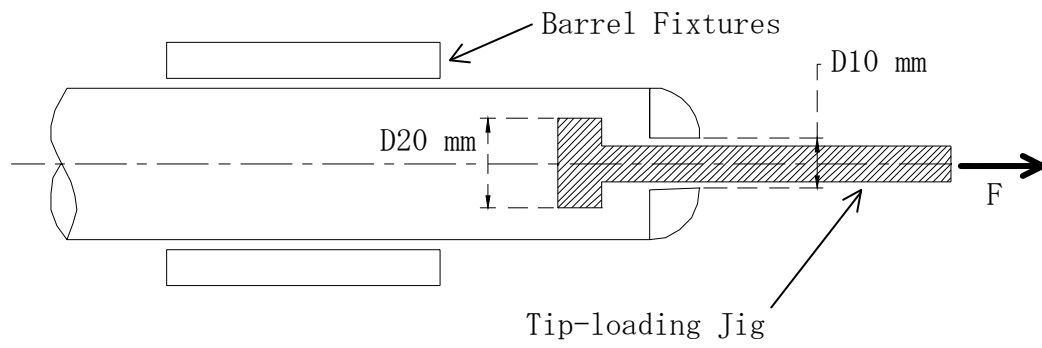
#### 2.2.6 Shape Requirement

The shape of a metal bat must have a "smooth incline" from the tip to the grip. The "smooth incline" is defined by two criteria. First, the value obtained by dividing the difference in the outer diameter of barrel and the outer diameter of grip by the length of taper should not exceed 10%. Second, the value obtained by dividing the difference in the diameters of a 50-mm long region taken from the steepest part of the taper by 50 should not exceed 20%. The purpose of this requirement is to prevent bat manufacturers from producing metal bats of extraordinary shape, which is significantly different from

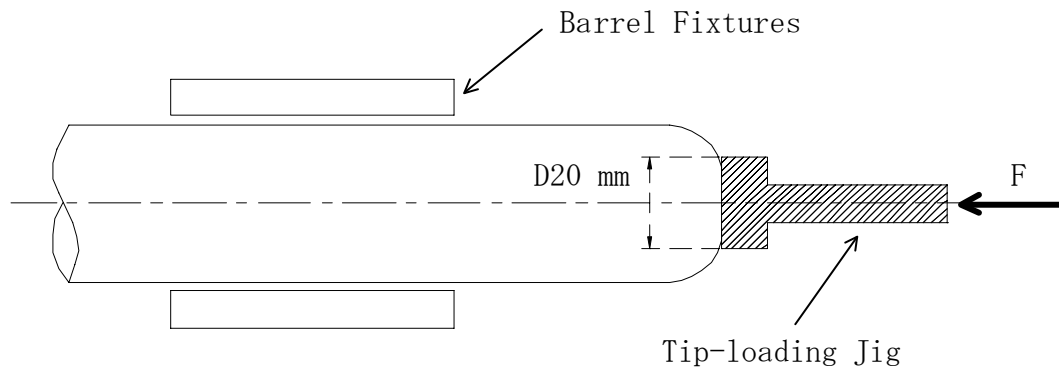
the contour of wood bats and is significantly different in batted-ball performance from wood bats. This restriction is driven from a principle that metal bats should not have shapes that wooden bats cannot have because the main purpose of the introduction of metal bats is to replace wooden bats.

### 2.2.7 Cap Test

The cap test consists of two tests: a cap pull test shown in Fig. 4 and a cap push test shown in Fig. 5. The purpose of the cap test is to confirm that the head cap of an aluminum bat is securely attached. The reason why this test was mandated is because there were aluminum bats with very thin flexible walls, and their caps were not securely attached. When a bat of this design is swung by strong batters, the cap flies into the air and potentially injures players. For the cap pull test, the cap is pulled by a jig with 500-N force and should not come out of the bat to pass the test. For the cap push test, the cap is pushed by a jig with 500-N force and should not be squeezed into the bat to pass the test.



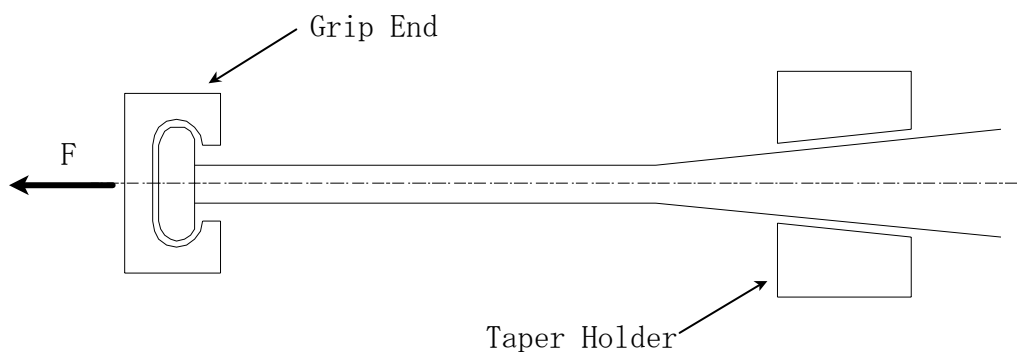
**Fig. 4: Cap pull test configuration**



**Fig. 5: Cap push test configuration**

### 2.2.8 Grip End Test

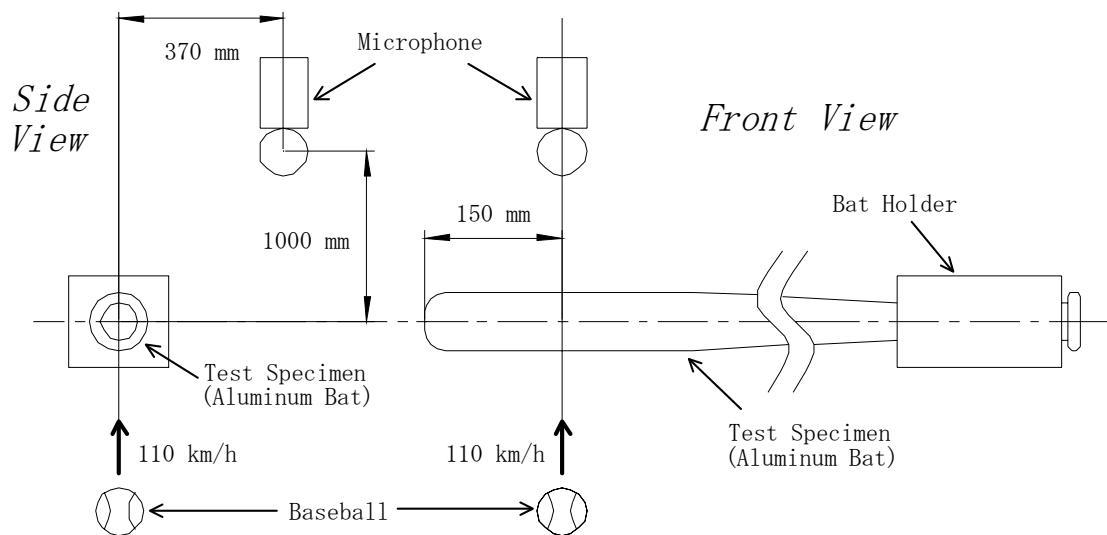
The grip end test examines the durability of the knob. In the early days of aluminum bat introduction, some aluminum bats had a durability problem with the welding of its grip end, and the knob sometimes came off during the swing motion of the bat. Losing the grip end during swinging brought potential danger for players to get hit by the bat when it came out of the hands of the batter. The grip end test is performed as shown in Fig. 6 by pulling the grip end at 10 mm/sec or slower speed. When the total force reaches to 300 N, the pulling grip end is stopped and held for 15 seconds.



**Fig. 6: Grip end test configuration**

### 2.2.9 Sound Test

The sound test measures the noise level of metal bats on impact. This test was established because there were concerns of the negative influence of the level of the sound on the batter's hearing and environmental noise. To pass the SG standard, first, the average of 10 noise level data, which are obtained from a microphone located at a specific location as shown in Fig. 7, is calculated. The noise level data are obtained by shooting a baseball at 110 km/h for 10 times to the point on the bat 150 mm from the tip. After the average is calculated,  $2\sigma$  (where  $\sigma$  denotes standard deviation of the noise level data) is added, and the result of the summation should not be more than 103 dB.



**Fig. 7: Sound test configurations**

### 3 METHODOLOGY

In this study, the performance of the U.S. aluminum bats and Japanese aluminum bats were compared. Methods used in this study to perform the comparison can be divided into three categories: BESR certification based methods, SG standard based methods, and tests and measurements that supplement these protocol based tests but belong to neither of the protocols.

#### 3.1 BESR Protocol

In this thesis, the results obtained from the BESR based certification methods were utilized for the comparison to the data obtained from other types of tests. The BESR based performance data were important for this thesis because the performance data were the only data that directly present the performance of the bats. To conduct the BESR-certification-method-based tests and compare the results for the bats, several steps were required to be followed.

##### 3.1.1 Preparation for the Test

In the usual BESR certification process, pretest measurements of bats must be performed before performance tests are conducted with the Baum Hitting Machine. The main purpose of the measurements is to profile a bat, to calculate the MOI of the bat, and to investigate whether the bat complies with the requirements of the BESR standard. Generally, the performance test of the bat by the BHM will not be performed when the



bat does not satisfy the requirement during the pretest measurements. However, because the purpose of this thesis is not to certify but to compare the bats, the compliance to the standard did not affect the process of the performance test. For example, even if the MOI of a bat is lower than the minimum allowable MOI established by the NCAA as shown in Table 1, the BESR certification based performance test of the bat was conducted in this thesis.

The pretest measurements of bats consist of several procedures. First, the location of the center of gravity, the length, and the weight of the bat without grip tape were measured and recorded. The location of the center of gravity would be used for calculating the MOI at the 6-inch (in front of the knob) location of the bat. From the length and the weight of the bat, the compliance with the -3 rule was confirmed. Next, the diameters at 3.0, 4.0, 5.0, 6.0, 7.0, 8.0, and 9.0-inch positions from the tip of the barrel, which are specified in the BESR protocol, were measured as shown in Fig. 8. Then the diameters at the 27.625- and 23.625-inch positions from the tip of the barrel, which are the locations of the axis of rotation and the end of grip for 33-inch bat, respectively, were also measured to obtain the rough profile of the handle of the bat.



**Fig. 8: Measuring the diameter of a bat**

Finally, the bat was installed in a pendulum fixture, shown in Fig. 9, to measure the period of the bat, which is one of the measurements needed to calculate the moment of inertia (MOI) of the bat. The distance from the pivot of the fixture to the end of the knob was also measured as shown in Fig. 10 so that the distance between the pivot and the center of gravity of the bat would be found. To calculate the MOI of the bat, Eq. 2 (Lerner 1996) was employed:

$$I = \frac{\tau^2 \cdot (d + L - L_{CG}) \cdot (m + m_{fix}) \cdot g}{4\pi^2} \quad \text{Eq. 2}$$

where:  $I$  is mass moment of inertia (MOI) of the bat [oz-in<sup>2</sup>]

$\tau$  is period of oscillation [s]

$d$  is distance from pivot to the knob end of the bat [in]

$L$  is length of the bat [in]

$L_{CG}$  is distance from the tip of the barrel to the center of gravity [in]

$m$  is mass of the bat [oz]

$m_{fix}$  is mass of the fixture [oz]

$g$  is acceleration due to gravity [in/s<sup>2</sup>]



**Fig. 9:** A bat in pendulum fixture

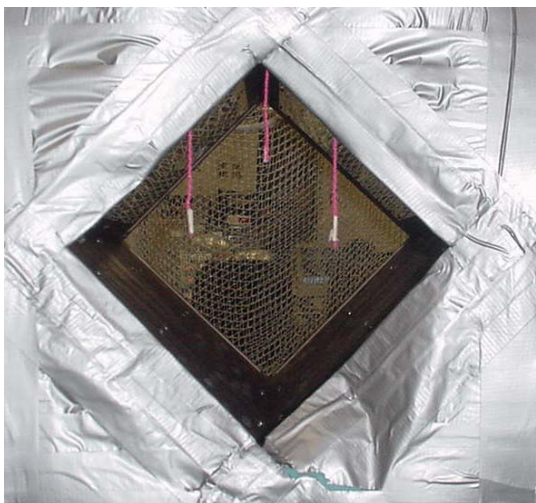


**Fig. 10:** Measuring the distance from pivot to knob end

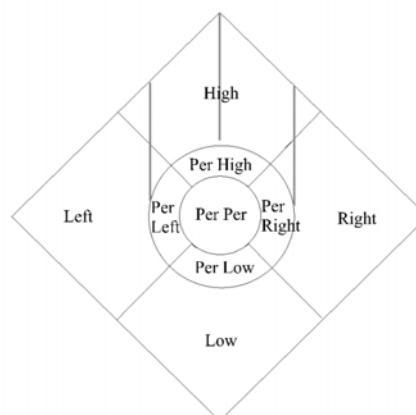
### 3.1.2 Performance Test by BHM

The BESR certification protocol specifies that the performance test starts with hits at the 6-inch (from the tip of the barrel) point. After five valid hits are taken at the 6-inch point, the impact position moves to 5-inch point. Five valid hits are taken at each point in the order of 6-inch, 5-inch, 7-inch, 5.5-inch, and 6.5-inch positions. The bat is randomly rotated after each hit to simulate player use of the bat in the field. The following criteria are for determining if a reading is valid:

- *The ball entry speed must be  $70 \pm 2$  mph, and the bat entry speed must be within  $\pm 1$  mph of prescribed value, which is 66 mph for the 6-inch location.*
- *The ball exit speed at the 72-inch speed-gate location must be less than the higher of the speeds at the 9-inch and 13-inch light-cell positions.*
- *When an exit ball goes through a target, shown in Fig. 11, which is located at 62-1/6 inches from the impact point, the ball must go through the center or the near center of the target. Specifically speaking, the targeting of the ball should be one of “per per”, “per left”, “per right”, “per high”, and “per left” in Fig. 12.*



**Fig. 11: Actual picture of the target  
(Drane 2003)**



**Fig. 12: Criteria for targeting  
(Drane 2003)**

As mentioned in the Background chapter, the BESR of the bat is calculated from Eq. 1 by substituting three speeds: the ball entry speed, the ball exit speed, and the bat entry speed at the 6-inch point. In the normal BESR certification procedure, the three speeds are obtained by averaging the five valid hits. Usually, as soon as the performance of the bat exceeds the BESR limit, which is determined by the ball certification process whose details are shown in the NCAA certification standard attached as Appendix A, the performance test is halted. However, in this thesis, the test was continued even if the BESR of the bat exceeded the limit during the test because the main purpose of this thesis is not to certify the bats but to compare the bats.

### 3.1.3 Adjustment Prior to Comparison

For this thesis, the BESR performance data for eight Japanese bats and three U.S. bats were collected. Though the performance data were collected by following the same procedure mentioned above, the data should not be used directly for the comparison, because not all the balls that were used for the performance tests belonged to the same lot. The performance of the baseballs can vary by the lots of the baseballs. Therefore, before the comparison in the performance was made, the obtained performance data had to be normalized so that all the data would be based on the same lot of balls. To perform the normalization, first, a baseline baseball lot must be determined. For this thesis, four lots of baseballs were used for testing the eleven bats: R29a, R30a, R32a, and R34a. For the normalization, the R30a lot balls were utilized as the baseline because seven of the eleven bats were tested with the balls of the R30a lot. The performance data obtained with Rxx lot ball was normalized by utilizing Eq. 3, which was derived by modifying the BESR equation and substituting specified ball entry speed and ball exit speed, and by scaling the performance by subtraction as shown in Eq. 4.

$$V_{besr} = BESR \times (66 + 70) + \frac{66 - 70}{2} \quad \text{Eq. 3}$$

$$V_{besr\_norm} = V_{besr} - (V_{Rxx} - V_{R30}) \quad \text{Eq. 4}$$

where: *BESR* is the Ball Exit Speed Ratio calculated from performance test

[nondimensional]

$V_{besr}$  is raw BESR based performance [mph]

$V_{besr\_norm}$  is BESR based performance after normalization [mph]

$V_{R30}$  is Exit speed of R30a lot ball obtained from the ball certification [mph]

$V_{Rxx}$  is Exit speed of Rxx lot ball obtained from the ball certification [mph]

### 3.2 SG Standard Based Test (Barrel Compression Test)

The barrel compression test is one of the required tests for aluminum bats under the SG standard. This test is performed to investigate if the resiliency of the barrel of a bat is lower than a specific limit and if the barrel is durable enough to meet a durability limit set by the Consumer Product Safety Association (CPSA) in Japan.

To perform the barrel compression test, first, the barrel of a bat must be cut into three equal-length rings. The SG approval standard states that the three rings should be taken from the barrel between the 50-mm and the 200-mm positions as measured from the tip of the bat. Fig. 13 shows three rings for a bat tested for this thesis. The length of each ring should be  $50 \pm 0.1$  mm unless there is any difficulty in obtaining rings of the length due to the structure or the length of the barrel of a bat. The length of a ring is defined as the average of two measurements obtained in each of the parallel and transverse directions.



**Fig. 13: Three rings taken from the barrel of a bat**

After three rings were obtained from a bat, their detailed dimensions, which were lengths of the ring at two points, outer diameters of the ring ends, inner diameters of the ring ends, ring weight, and wall thicknesses at ring ends, were measured and recorded. Those measurements were taken with a dial caliper. The only dimensions directly related to the barrel compression tests were length and outer diameters of the rings. However,

the rest of the dimensions were also measured because these data would be required for calculating the partial mass of the bat, which could be related to the MOI difference.

For performing the barrel compression test, an Instron Testing Machine 8511 with a load cell of 5000 lb was utilized. For supporting the ring during the test, a typical base with horizontal surface could not be used because the diameter of the ring was not always constant, and the force would not be applied in the normal direction. To make the force to be applied normal regardless of the shape of the taper of the rings, an adjustable base was employed as shown in Fig. 14. On applying the force on the ring, the speed of the head was set to 10 mm/sec or slower, which is specified in the protocol. The data were recorded on the PC in digital format.





**Fig. 14: A ring on an adjustable base for compression test**

After enough preload was applied to secure the ring to the base, a force was applied on the ring with a cross-head displacement speed of less than 10 mm/sec. The force was applied on the ring until the displacement reached 20% of the original outer diameter of the ring ( $0.2D_0$ ). At this point in the test procedure, it was confirmed whether or not the total force applied exceeded 10,000 N (2248 lb force). When the displacement had reached  $0.2D_0$  without reaching the total force of 10,000 N, additional force had to be applied until the total force reached 10,000 N. Also, when the total force had reached 10,000 N without reaching the displacement of  $0.2D_0$ , the additional force had to be applied until the displacement reached  $0.2D_0$ . Regardless of the pass or fail criteria, the test was halted as soon as the ring cracked.

From the data obtained from the barrel compression test, a plot of load vs. displacement was generated for each ring. The offset load that corresponded to the residual displacement  $0.02D_0$  was obtained graphically from the plot as shown in Fig. 3.

The SG protocol requires all three rings to have the offset load of 7500 N or more for an aluminum bat for general players to pass the standard. However, the 7500-N limit is valid only when the ring length is  $50 \pm 0.1$  mm. The SG protocol states that the load value must be converted in accordance with the specified limit if a ring with the specific length is not used. In this thesis, most rings tested did not satisfy the length condition due to the difficulty in cutting the bats with such high precision. Therefore, the offset load data had to be recalculated to satisfy the length condition by utilizing the Eq. 5 (Tokieda, 2003):

$$OL = OL_{original} \cdot \frac{50}{L_{ring}} \quad \text{Eq. 5}$$

where:  $OL$  is the corrected offset load [N]  
 $OL_{original}$  is the original offset load value obtained from the graph [N]  
 $L_{ring}$  is the length of the ring [mm]

### 3.3 MOI Comparison

The ease of swing of a bat is directly related to the mass moment of inertia (MOI) of the bat. The MOI difference of bats can depend on the difference in mass distribution of the bats. Because aluminum bats are hollow unlike wood bats, the mass distribution of the bats can be varied by the wall-thickness distribution.

One of the NCAA protocols specifies the minimum allowable MOI at the 6-inch position from the base of the knob of the bat as shown in Table 1. The MOI at the 6-inch position can be calculated by employing Eq. 2. To compare the MOI of the U.S. bats and Japanese bats, the MOIs at the 6-inch position of the bats were calculated. However, the MOI values and the performance data obtained from the BHM should not be used directly to compare and to find the relationship between MOI and performance. The BHM swings all of the bats at the same velocity regardless of MOI. As a result, the BHM may output higher performance for higher MOI bats than would be seen in typical use, and vice versa for relatively low MOI bats. Therefore, the effect on performance due to MOI difference must be included by employing an empirical relation between a change in MOI and a change in swing speed shown in Eq. 6 (Fleisig *et al.* 2002) and a modified BESR equation shown in Eq. 7.

$$\Delta V_t = (-6.6 \cdot 10^{-4}) \cdot (\Delta MOI) \quad \text{Eq. 6}$$

$$v'_b = BESR \cdot (V + \Delta V_t + v) + (V + \Delta V_t + v) / 2 \quad \text{Eq. 7}$$

where:  $\Delta V_t$  is change in swing speed at 6-in location due to MOI [mph]  
 $v'_b$  is batted-ball velocity [mph]  
 $V$  is the original bat swing speed [mph]  
 $v$  is the ball entry speed [mph]

### 3.4 Wall Thickness Measurement and Partial Weight Comparison

For the wall thickness measurement, a Parametrics 25DL PLUS ultrasonic thickness gage, shown in Fig. 15, was utilized. The measurements were taken with the device instead of a traditional dial caliper, because the device could measure the wall thickness of the bat by measuring the time required for the ultrasonic wave to travel from the OD to the ID and back to the OD in the material. Thus, modifying or damaging the bat was not needed. Therefore, it was possible to measure the wall-thickness distribution of the bat before the performance of the bat was tested with the BHM, which could potentially affect the properties and dimensions of the bat. It was also possible to measure the wall thickness at a number of positions on the bat, which would require the bat to be cut into pieces if the dial caliper was used for wall-thickness measurements.

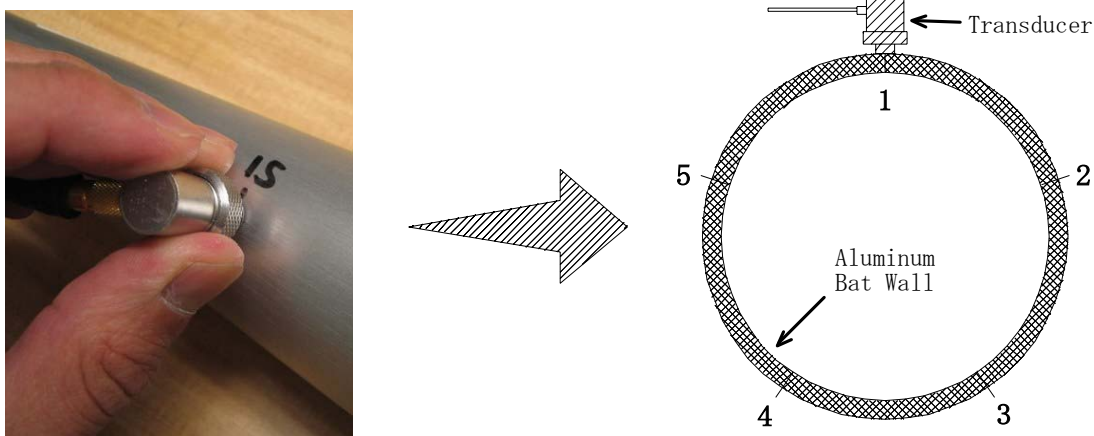


**Fig. 15: Wall-thickness measurements with the ultrasonic thickness gage**

The velocity of the ultrasonic wave is critical for measuring the wall thickness of the material correctly. The gage has several predefined velocity settings for various

materials such as steel. However, there were no velocity settings for the alloy materials used for the aluminum bats, such as A7075 and A7050. For the velocity setting to measure the wall thickness, a velocity setting, which was obtained experimentally from a C500 aluminum plate of a known thickness, was utilized.

Because the wall-thickness measurements were performed without destroying the bats, it was impossible to investigate if the wall thickness of bats was uniform for each position. Therefore, for performing the wall-thickness measurements, the wall thicknesses of five locations were taken for each position as shown in Fig. 16, and the average and the standard error of the mean of the measurement results were calculated.



**Fig. 16: Five locations at each position for wall-thickness measurement**

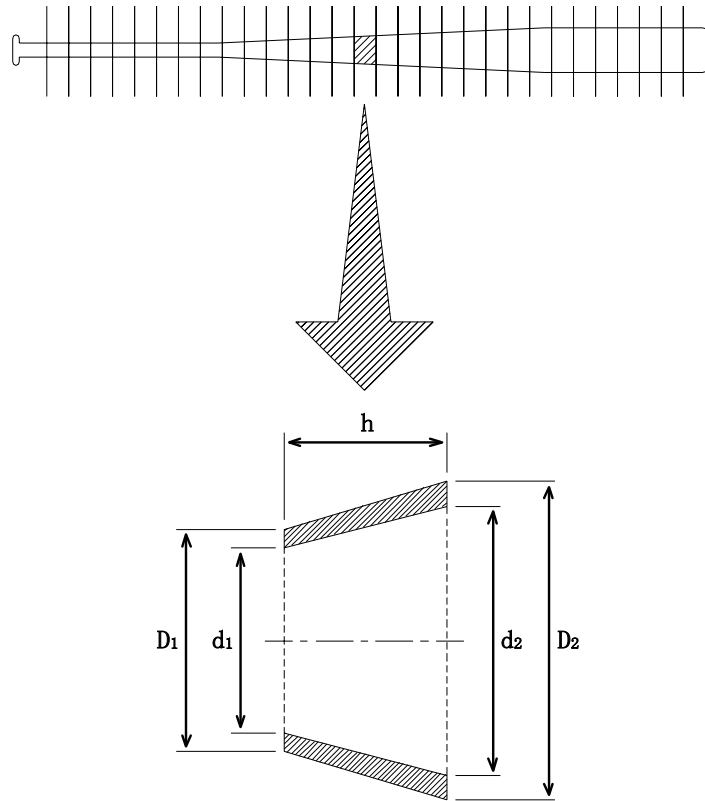
Though the comparison of wall-thickness distributions of the bats could be performed from the values obtained by the method mentioned above, the wall-thickness measurement results must be corrected because the results were based on an assumption that the bat material was C500 aluminum. To perform the correction, the actual wall thickness of a ring, which was taken after the performance test was completed, was measured with a dial caliper. Because the ultrasonic thickness gage calculates the wall

thickness of a material by simply multiplying the velocity of the ultrasonic wave by the time required for the wave to go through the material, a proportional relationship, shown in Eq. 8, was utilized to obtain the real wall thickness.

$$t_{real} = t_{ultrasonic} \cdot \frac{t_{ring\_caliper}}{t_{ring\_ultrasonic}} \quad \text{Eq. 8}$$

where:  $t_{real}$  is the real wall thicknesses of the bat [in]  
 $t_{ultrasonic}$  is wall thicknesses of the bat obtained with the ultrasonic gage [in]  
 $t_{ring\_caliper}$  is wall thickness of the ring obtained with the dial caliper [in]  
 $t_{ring\_ultrasonic}$  is wall thickness of the ring obtained with the ultrasonic gage [in]

Finding the distribution of wall thicknesses for a bat makes it possible to calculate the partial mass distribution of the bat. Investigating the wall-thickness distribution is important because the wall-thickness distribution along the length of a bat is a major factor that determines the MOI of an aluminum bat. However, the weight distribution of the bat could not be estimated directly from the wall-thickness distribution because the diameter of the bat is nonuniform. To estimate the weight distribution of the bat clearly, an idea that cutting the bat into a number of imaginary 1-inch length rings as shown in Fig. 17 was utilized. This idea basically assumes each ring as a tapered ring to calculate the volume of the ring by employing either Eq. 9 or Eq. 10, which were derived from a basic algebra formula for obtaining the volume of a cone. The density of the material of the bat is multiplied by the volume to obtain an estimate of the weight of the ring.



**Fig. 17: Taking out an imaginary ring of a bat**

When  $D_1 \neq D_2$  and  $d_1 \neq d_2$ :

$$V_{ring} = \frac{1}{3} \pi h \left( \frac{D_2^2}{4} + \frac{D_1 D_2^2 - D_1^3}{4(D_2 - D_1)} \right) - \frac{1}{3} \pi h \left( \frac{d_2^2}{4} + \frac{d_1 d_2^2 - d_1^3}{4(d_2 - d_1)} \right) \quad \text{Eq. 9}$$

When  $D_1 = D_2$ :

$$V_{ring} = \left( \frac{D_1}{2} \right)^2 \pi h - \frac{1}{3} \pi h \left( \frac{d_2^2}{4} + \frac{d_1 d_2^2 - d_1^3}{4(d_2 - d_1)} \right) \quad \text{Eq. 10}$$

where:  $V_{ring}$  is the volume of the ring [ $\text{in}^3$ ]

$D_1$  is the outer diameter of the ring on one side [in]

$d_1$  is the inner diameter of the ring on the same side as  $D_1$  [in]

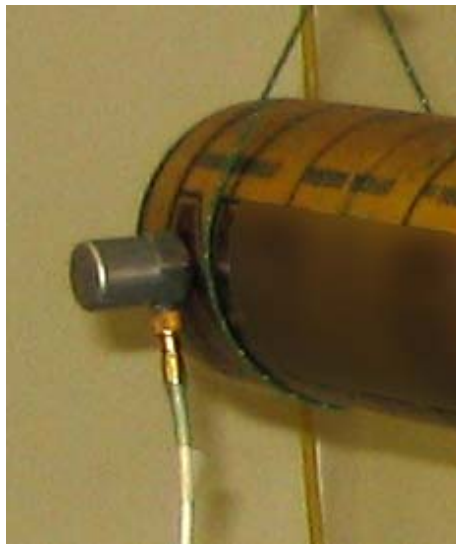
$D_2$  is the outer diameter of the ring on the other side from  $D_1$  [in]

$d_2$  is the outer diameter of the ring on the same side as  $D_2$  [in]

$h$  is the length of the ring [in]

### 3.5 Modal Tests and Center of Percussion (COP) Comparison

The purpose of the modal test is to investigate if there exists any correlation between performance and the bending nodes of a bat, which are defined as the points of zero displacement of fundamental vibration. The modal analysis experiment of the bats was performed by utilizing a setup that consisted of an HP 35665A Dynamic Signal Analyzer, an accelerometer, and an impact hammer. During the experiment, the bat was suspended at each end with strings, and the accelerometer was attached to the barrel of the bat as shown in Fig. 18 so that the dynamic property of the bat would not change dramatically due to the mass of the accelerometer.



**Fig. 18: Accelerometer attached to the barrel of the bat**

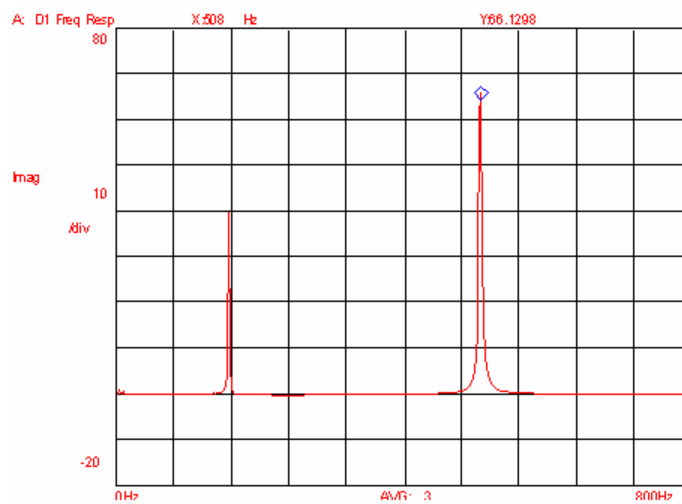
For obtaining the natural frequency and the node points of a bat, the Frequency Response Function (FRF) was utilized. As soon as the bat was impacted with the impact hammer as shown in Fig. 19, the natural frequency of the bat was obtained from the FRF. The natural frequency should be found at the point where the greatest peak of curve



appears in the FRF as shown in Fig. 20. When multiple identical peaks were found, the first peak was considered as the natural frequency of the bat.

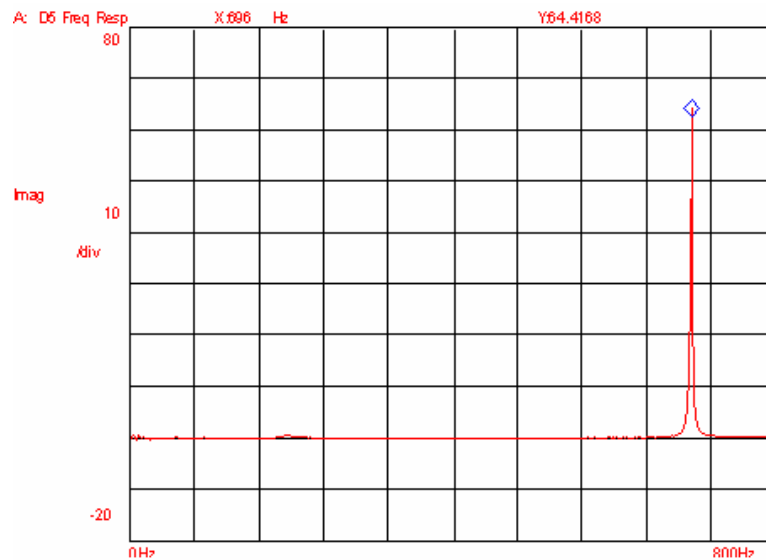


**Fig. 19: Impacting a bat with an impact hammer**



**Fig. 20: FRF displayed on analyzer**

After the natural frequency was obtained, the node points were found. To find the node points, several impacts were performed until the impact point where the first peak of the FRF disappeared, as shown in Fig. 21, was located. Then the impact point, which was the first node of the bat, was marked on the bat, and the location of the first node was measured with a ruler. Similarly, several impacts were performed until the impact point where the second peak of the FRF disappeared was found. The impact point was the second node of the bat and was marked on the bat and its location was measured with the ruler.



**Fig. 21: FRF when the first node was impacted**

After the node points of the bats were found, the node point locations were overlaid on the BESR-based performance graphs, which were discussed in Section 3.1, with the locations of the COPs. The graphs were utilized for investigating any

correlation between the performances and the locations of the node points and the COPs of the bats.

By following the methods presented in this chapter, the differences among the bats in performance and static properties were examined quantitatively. From the quantitative data, whether or not there exists any correlation between performance and other static test data were explored.

## 4 RESULTS / DISCUSSION

This chapter presents the results that were obtained from the tests and measurements performed by following the procedures mentioned in Chapter 3, Methodology. For this work, eight SG-compliant aluminum baseball bats for general players and three BESR compliant aluminum baseball bats were investigated. The SG-compliant baseball bats were selected for comparison because the BESR compliant bats were designed for NCAA baseball players and high school students, who will be classified as general players under the SG protocol. Table 2 presents brief information of the eleven bats and the lot numbers of the baseballs used for testing the eleven bats.

**Table 2 : Bat identification for this thesis**

<i>Bat ID</i>	<i>Country</i>	<i>Compliance</i>	<i>Length (in)</i>	<i>Weight (oz)</i>	<i>Ball Lot</i>
SN01	Japan	SG	33.063	31.445	R30a
SN02	Japan	SG	33.063	31.425	R30a
SN03	Japan	SG	32.938	31.590	R30a
SN04	Japan	SG	33.063	31.240	R30a
SN05	Japan	SG	32.875	31.965	R30a
SN06	Japan	SG	33.188	31.605	R30a
SN07	U.S.	BESR	33.000	30.375	R30a
SN08	U.S.	BESR	33.125	30.235	R32a
SN09	U.S.	BESR	33.000	29.985	R29a
SN10	Japan	SG	33.063	31.390	R34a
SN11	Japan	SG	32.938	30.990	R34a

In this study, for simplification, the eight SG-compliant bats are called, “Japanese bats”, and the three BESR-compliant bats are called, “U.S. bats”.

#### 4.1 BESR Performance Data

This section presents the performance data, which were obtained from the Baum Hitting Machine by following the BESR certification protocol established by the NCAA, of the eleven bats. As mentioned in Section 3.1.3, the raw performance data could not be used directly for comparison due to the difference in ball lots used for the performance tests. The performance data presented in this section take into account the ball-lot difference by utilizing Eq. 4. The exit speeds obtained from the ball certification for each ball lot, which were required information for using Eq. 4, are shown in Table 3.

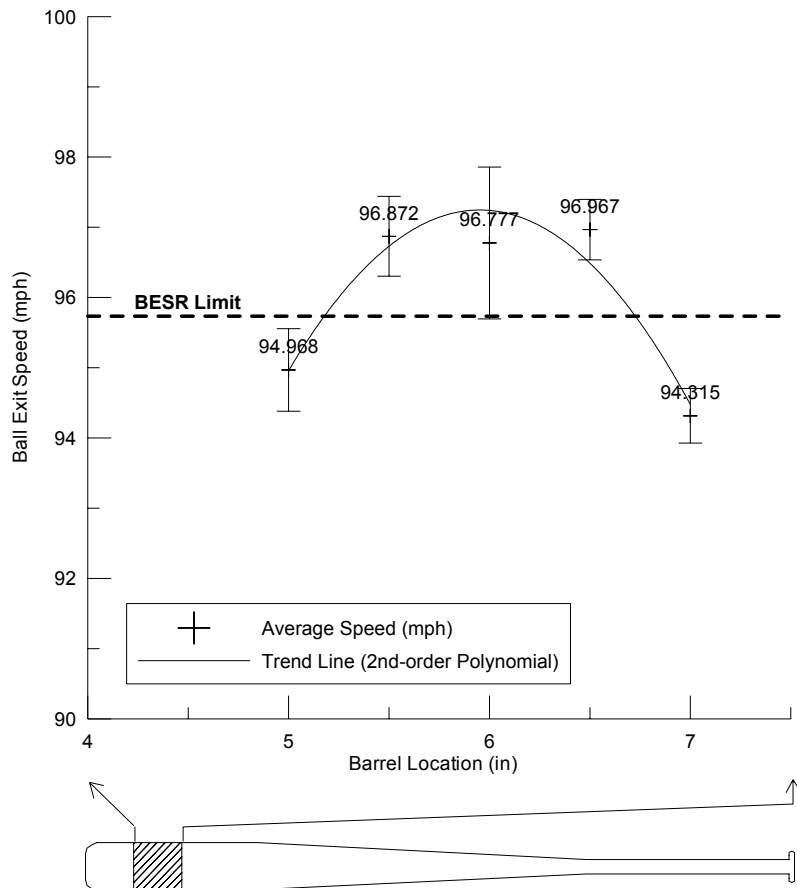
**Table 3 : Information about the baseball lots used for performance test**

<i>Ball Lot</i>	<i>Exit Speed</i> $V_{Rxx}$ (mph)	<i>Bats Tested</i>
<b>R30a</b>	95.735	SN01, SN02, SN03, SN04, SN05, SN06 and SN07
<b>R32a</b>	95.598	SN08
<b>R29a</b>	96.085	SN09
<b>R34a</b>	97.209	SN10 and SN11

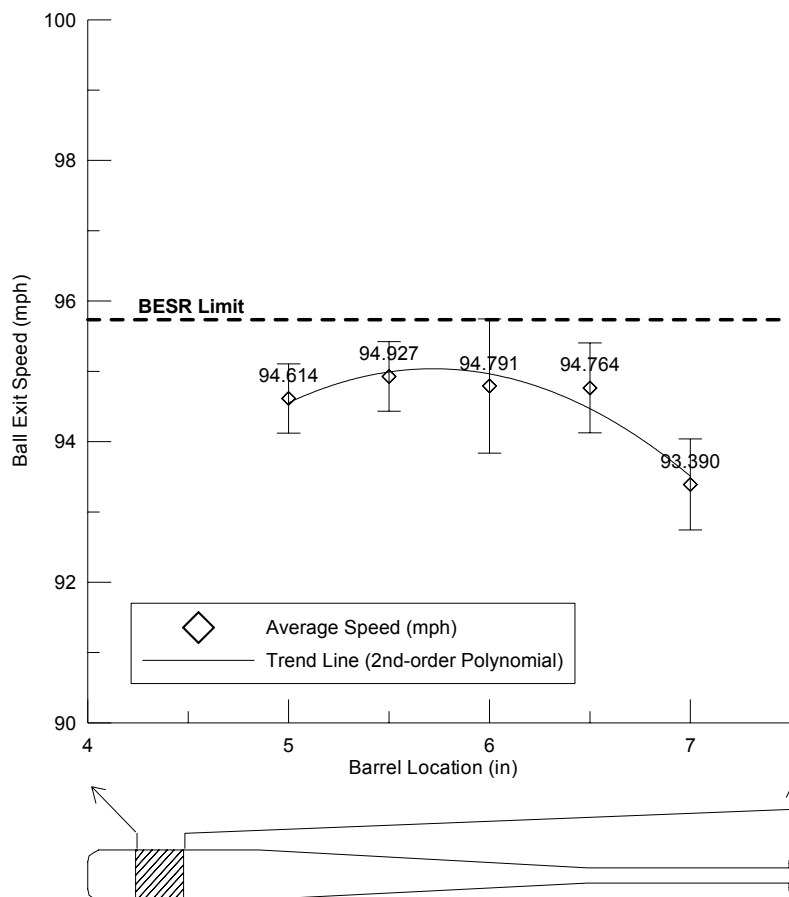
##### 4.1.1 BESR Performance for Japanese Bats

Fig. 22 through Fig. 29 represent the batted-ball performance data and the trend line for each Japanese bat. The x-axes and y-axes of all the figures represent the impact position on the bats and the batted-ball speed, respectively. A horizontal dotted line, shown in each figure, represents the ball exit speed converted from the BESR limit for the baseball lot R30a. The BESR limit for the baseball lot R30a is 0.7186, which correlates to an exit speed of 95.735 mph. Data points in the figures, whose symbols vary by the model of bats, with IDs as given in Table 2 represent the average of the batted-ball speeds for each position. Error bars shown in the figures represent the

standard error of the mean of five batted-ball speeds for each position. For performance trend lines, 2nd-order polynomial parabolas were used because the performance trend of mathematical baseball bat model was the 2nd-order polynomial curve. Fig. 22 shows that the performance of SN01 clearly exceeded the BESR performance limit, which was calculated by substituting the original BESR limit value into Eq. 3. Unlike SN01, SN02 performed within the BESR limit as shown in Fig. 23, and its trend line was relatively flat, which meant that the batted-ball speeds at several positions along the barrel were very similar.

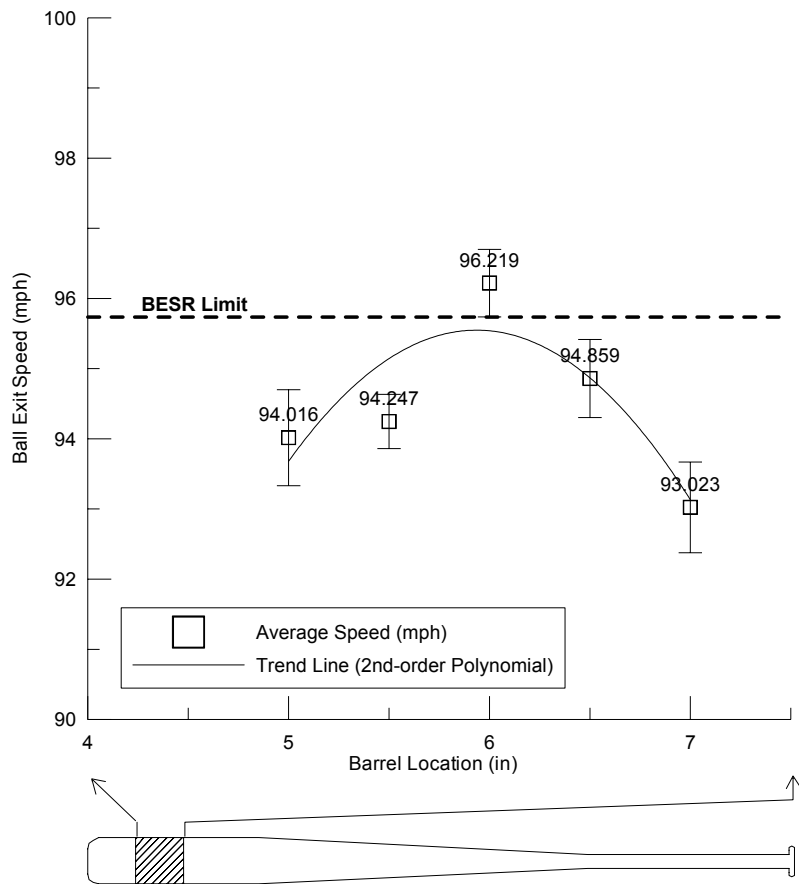


**Fig. 22: Batted-ball performance data for SN01**



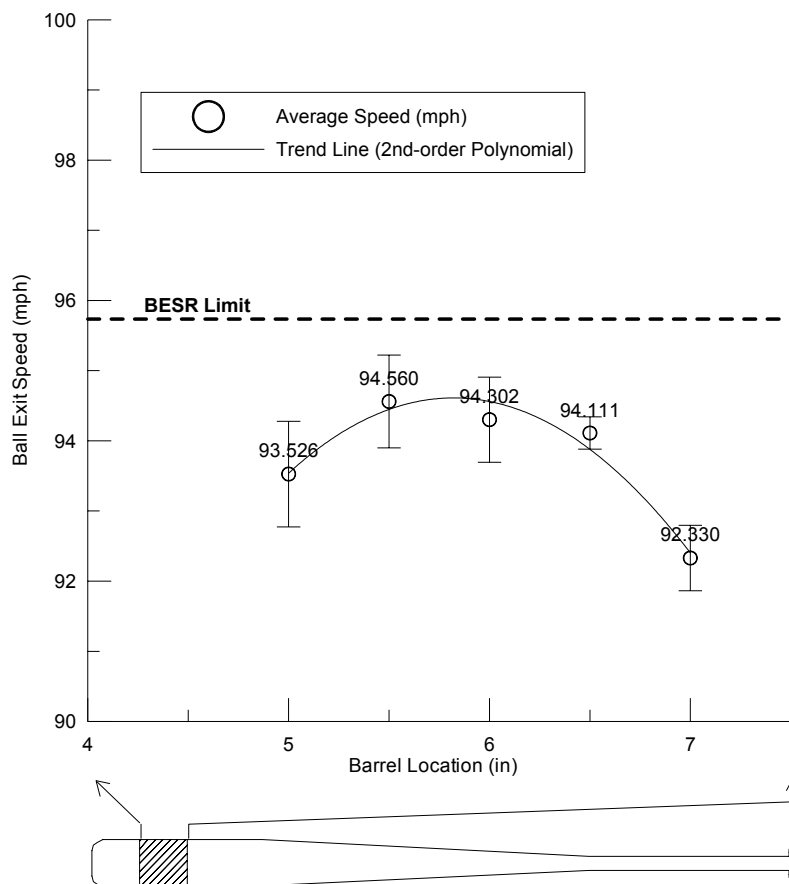
**Fig. 23: Batted-ball performance data for SN02**

The trend line of performance for SN03, shown in Fig. 24, was within the BESR performance limit. Unlike SN02, the bat had a clear sweet spot, and the average batted-ball speed at the 6-inch position was above the limit. The performance of SN04, shown in Fig. 25, was somewhat similar to that of SN02. However, the performance of SN04 decreased more clearly than SN02 on the outside of its sweet spot.



**Fig. 24: Batted-ball performance data for SN03**

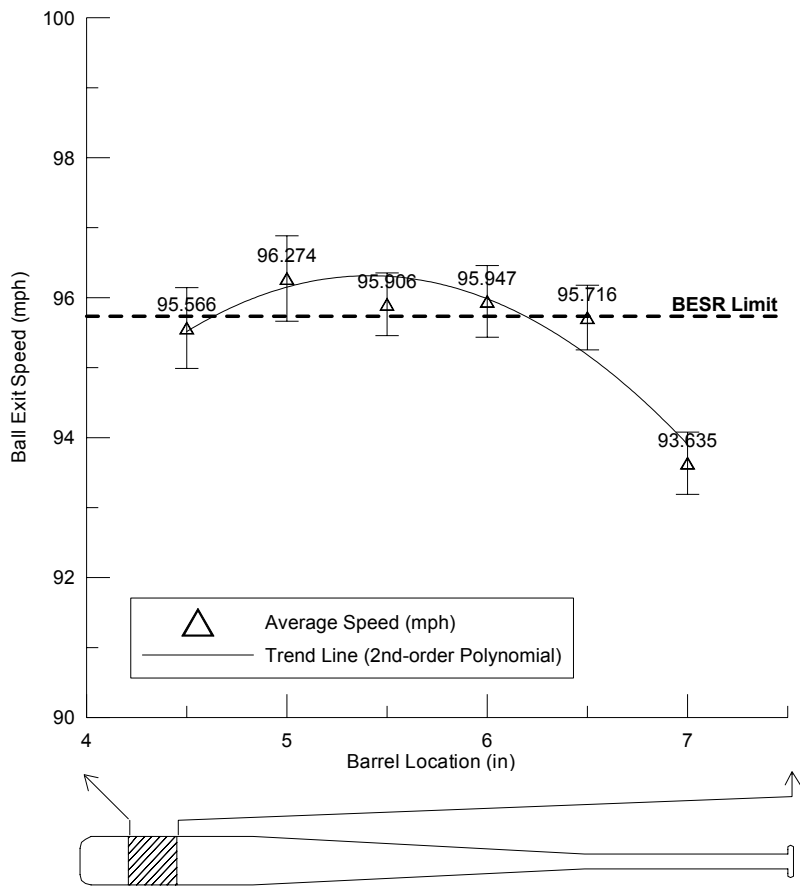




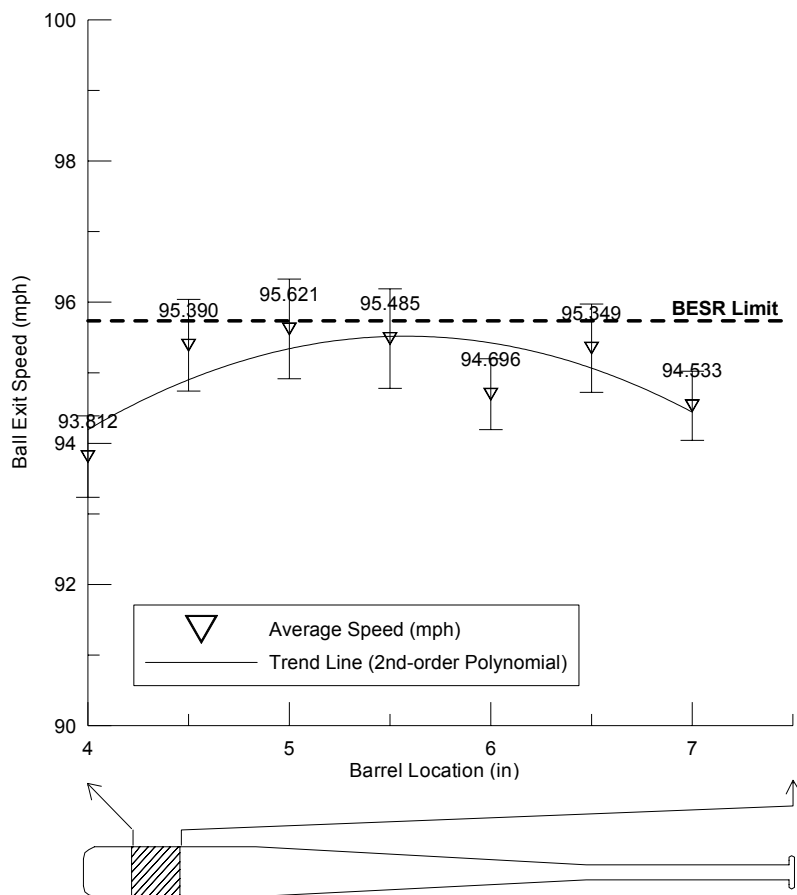
**Fig. 25: Batted-ball performance data for SN04**

Most of the eleven bats were tested for their performance at the five positions, which were 5.0, 5.5, 6.0, 6.5, and 7.0 inches from the tip of barrel. However, SN05, shown in Fig. 26, and SN06, shown in Fig. 27, were also tested at their 4.5-inch position, and SN06 was additionally tested at its 4.0-inch position. The reason why the performance at these additional positions was tested was that the BESR protocol requires the performance test to be continued until the position 0.5-inch on either side of the sweet spot is tested. For example, when the performance at the 5.0-inch position is the highest among the performance values at the five positions, the performance at the 4.5-inch position must be tested so that it will be possible to judge whether or not the 5.0-inch

position is the sweet spot of the bat. For SN06, the performance at the 4.0-inch position was measured because its performance at 4.5-inch position and 5.0-inch position were too close to call that the 5.0-inch position was the sweet spot of the bat.

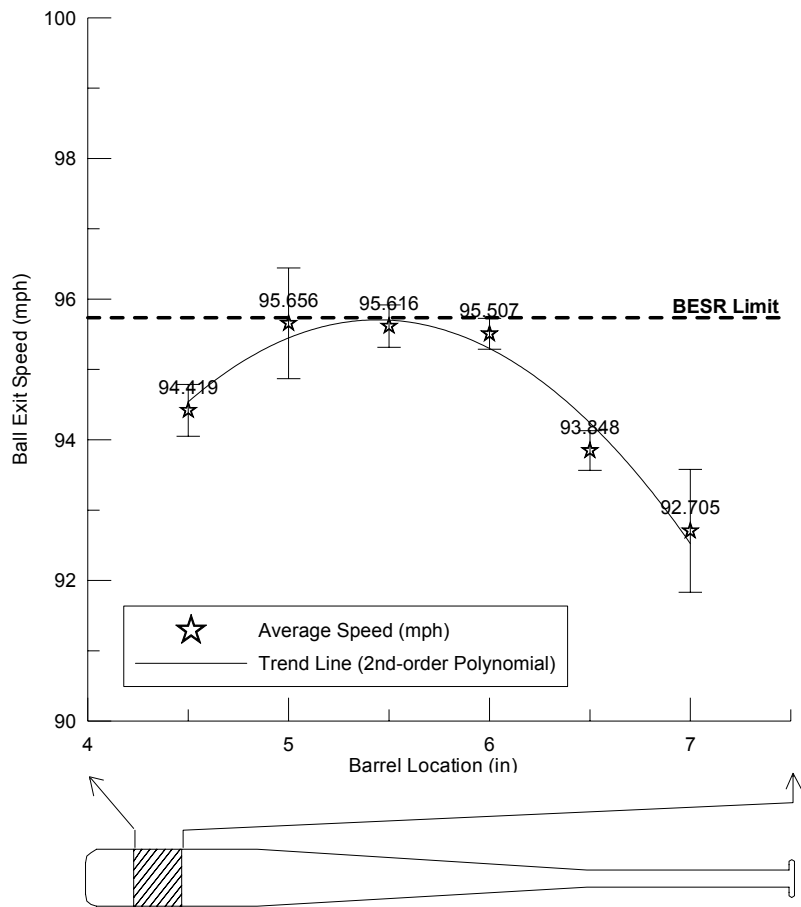


**Fig. 26: Batted-ball performance data for SN05**

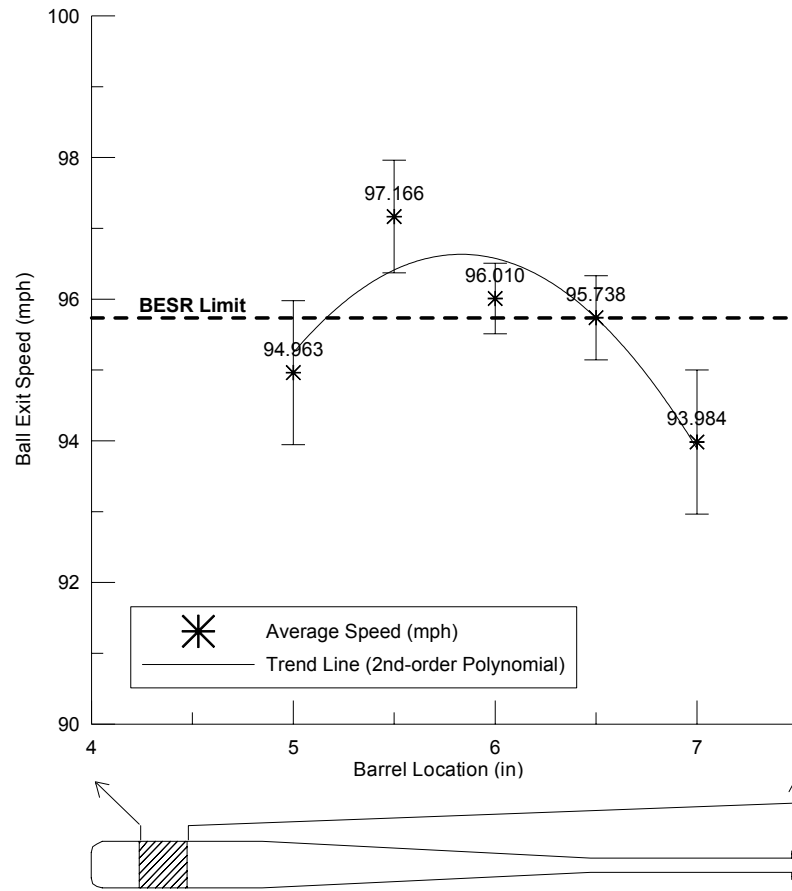


**Fig. 27: Batted-ball performance data for SN06**

Like SN05, SN10 was also additionally tested at its 5.0-inch position as shown in Fig. 28. However, unlike SN05, the performance did not exceed the BESR performance limit. SN05 performed almost uniformly in its wide sweet-spot region, which was 4.5- through 6.5-inch positions, while the performance of SN10 was uniform between its 5.0- and 6.0-inch positions and dropped dramatically outside of its sweet spot range. SN11, shown in Fig. 29, was one of two bats; the other bat was SN01, which clearly exceeded the BESR performance limit. Though the trend line of SN01 had its apex at a higher batted-ball speed than that of SN11, the actual highest performance among the eleven bats was recorded by SN11 at its 5.5-inch position.



**Fig. 28: Batted-ball performance data for SN10**

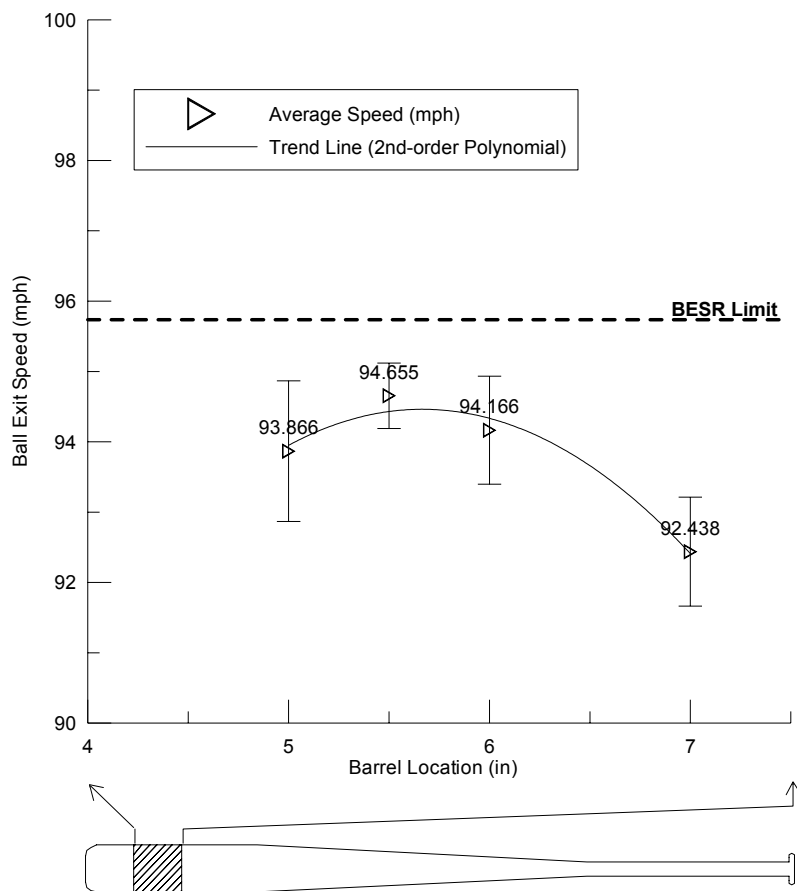


**Fig. 29: Batted-ball performance data for SN11**

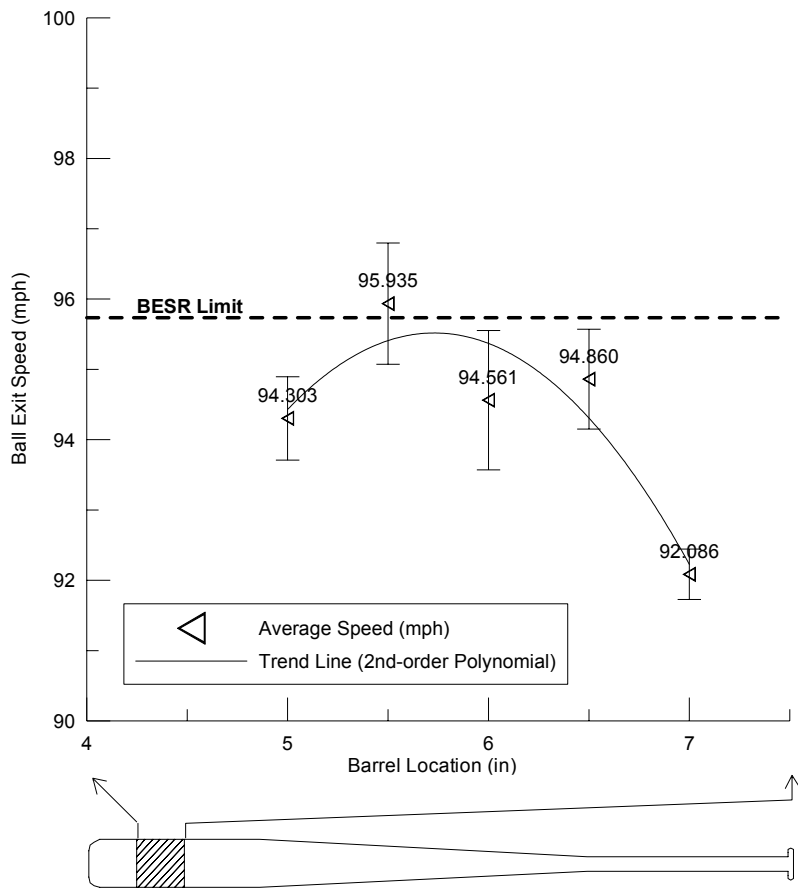
#### 4.1.2 BESR Performance for U.S. Bats

The BESR performances of the three U.S. bats are presented in Fig. 30 through Fig. 32. The performance data of SN07 for 6.5-inch position are missing in Fig. 30 because the data were obtained from the BESR certification database. As mentioned in Section 3.1.2, the usual BESR certification process does not require testing all five positions of a bat as long as the sweet spot of the bat is isolated clearly. Fig. 30 and Fig. 32 show that the performances of SN07 and SN09 were clearly below the BESR performance limit. However, the performance of SN08, shown in Fig. 31, slightly exceeded the limit. None of the three models was not supposed to exceed the limit

because the bats were designed to pass the BESR standard. However, exceeding the limit can happen because of the variation in the quality of the final products. With respect to the sweet spots of the bats, all three U.S. bats had their sweet spots at the 5.5-inch position. Having the same sweet spot location is a coincidence and not a requirement for BESR bats.

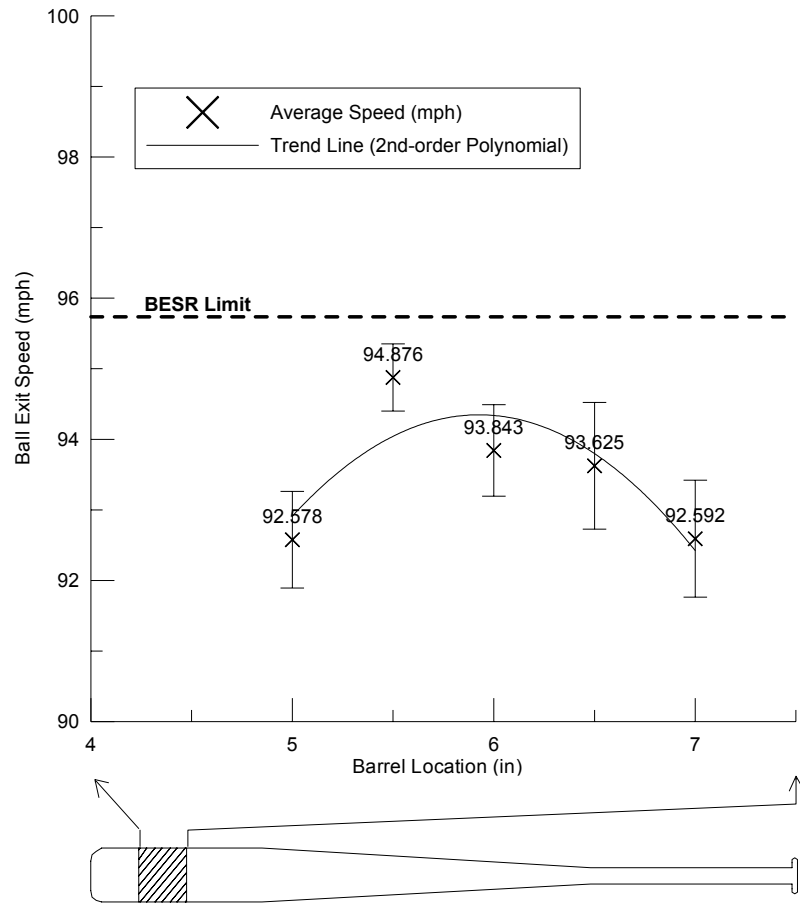


**Fig. 30: Batted-ball performance data for SN07**



**Fig. 31: Batted-ball performance data for SN08**



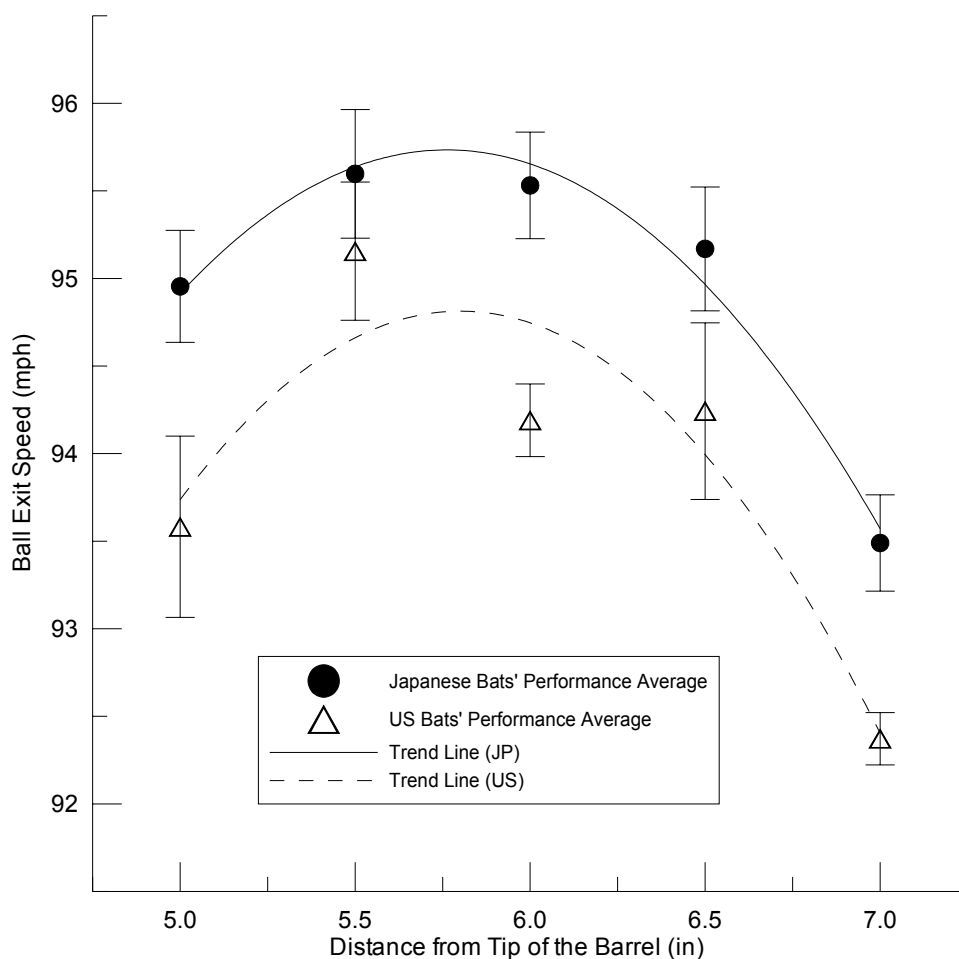


**Fig. 32: Batted-ball performance data for SN09**

#### 4.1.3 Overall BESR Performance Comparison Results

The performance test results showed that four Japanese bats (SN01, SN03, SN05, and SN11) exceeded the limit set by the BESR, while the other four Japanese bats and two of the U.S. bats performed within the limit. From the figures, it was found that all the bats tested in this study had their sweet spots in the region of the 5.5-inch and 6.0-inch positions. Except for SN06, all of the bats had the lowest performance spots at the 7.0-inch position.

Though Figs. 22 through 32 clearly present the performance of each bat, it was difficult to compare the differences in performance among the Japanese bats and U.S. bats using only these figures. Therefore, the average of eight Japanese bat performances and that of three U.S. bat performances were taken and compared as shown in Fig. 33. For Fig. 33, the performances at the 4.0-inch and 4.5-inch positions are omitted because not all bats were tested at these positions. As shown in Fig. 33, the Japanese bats and the U.S. bats have similar trends, but the average performance of the Japanese bats is about 1 mph greater than that of U.S. bats.



**Fig. 33: Comparison in performance average of U.S. and Japanese bats**

Although the BESR test provides performance data for each position on each bat and its performance trend line, it was not practical to utilize the performance data for multiple impact positions when investigating any correlation between performance and the data that were obtained from other non-BESR tests. In the BESR protocol, the most important data to judge if a bat passes or fails the BESR certification is the performance at the sweet spot of the bat, which is typically the maximum batted-ball speed of the bat. Therefore, in this work, the batted-ball speed at the sweet spot of a bat was utilized as the representative of the performance of the bat except for modal test and COP comparison, which do not require the information about the location of sweet spot of bats. The maximum batted-ball speed of each bat is shown in Table 4. The data in the table reflects the effect of the normalization for baseball lot used in the BHM testing by using Eq. 4.

**Table 4: Maximum performance of the bats**

<i>Bat ID</i>	<i>Maximum Batted-Ball Speed (mph) *</i>
<b>SN01</b>	96.967
<b>SN02</b>	94.927
<b>SN03</b>	96.219
<b>SN04</b>	94.560
<b>SN05</b>	96.274
<b>SN06</b>	95.621
<b>SN07</b>	94.655
<b>SN08</b>	95.935
<b>SN09</b>	94.876
<b>SN10</b>	95.656
<b>SN11</b>	97.166

\* Maximum Batted-Ball Speeds are adjusted to normalize for baseball lot used in BHM testing

Table 4 clearly presents that SN11 had the highest maximum batted-ball speed, and SN01 had the second highest maximum batted-ball speed in the bats.

## 4.2 Barrel Compression Test Data

In this section, the offset loads, which were obtained from the barrel compression tests by following the SG protocol mentioned in Section 3.2, for each bat are presented. The SG protocol requires all three rings for each aluminum baseball bat to have offset loads of 7500 N or more when the bat is designed for general players. Like the case of the BESR performance data, the raw barrel compression test data could not be used directly for comparison because the lengths of the rings were not always  $50\pm 0.1$  mm. Therefore, prior to obtaining correct offset loads, the raw compression test data were normalized for the 50-mm long ring by employing Eq. 5.

### 4.2.1 Offset Loads for Japanese Bats

The offset loads for the rings taken from Japanese bat are presented in Table 5. It was found that the average offset loads for all of the Japanese bats exceeded 7500 N, which is the specified minimum value for aluminum baseball bats for general players. The offset load of one of the three rings taken from SN01 was 7.49 kN, which was below the limit. Like the BESR performance of SN08, which exceeded the BESR limit at 5.5-inch position though the bat was designed to pass the BESR regulation, the offset load issue of SN01 could be due to the variation in manufacturing quality.

**Table 5: Offset loads of rings of Japanese bats**

<i>Bat ID</i>	<i>Ring ID</i>	<i>Offset Load (kN)</i>	<i>Average Offset Load (kN)</i>	<i>Average Wall-Thickness (in)</i>
<b>SN01</b>	<b>1</b>	7.49	7.72	0.123
	<b>2</b>	8.10		0.122
	<b>3</b>	7.59		0.119
<b>SN02</b>	<b>1</b>	7.97	8.22	0.125
	<b>2</b>	8.26		0.125
	<b>3</b>	8.41		0.123
<b>SN03</b>	<b>1</b>	8.42	8.14	0.126
	<b>2</b>	8.06		0.122
	<b>3</b>	7.95		0.120
<b>SN04</b>	<b>1</b>	7.90	7.88	0.121
	<b>2</b>	7.98		0.123
	<b>3</b>	7.75		0.118
<b>SN05</b>	<b>1</b>	7.90	7.84	0.122
	<b>2</b>	7.98		0.124
	<b>3</b>	7.64		0.120
<b>SN06</b>	<b>1</b>	7.85	8.21	0.125
	<b>2</b>	8.30		0.126
	<b>3</b>	8.47		0.124
<b>SN10</b>	<b>1</b>	7.53	7.56	0.123
	<b>2</b>	7.53		0.122
	<b>3</b>	7.62		0.118
<b>SN11</b>	<b>1</b>	7.81	8.31	0.124
	<b>2</b>	8.47		0.121
	<b>3</b>	8.66		0.123

#### 4.2.2 Offset Loads for U.S. Bats

Table 6 presents the offset loads of rings taken from U.S. bats. Unlike the case of Japanese bats, none of U.S. bats had offset loads of 7500 N. Among the three U.S. bats, SN07 had the lowest offset loads. However, this bat had a bladder in its barrel. Therefore, the apparent resiliency of the bat might be similar to the other U.S. bats.

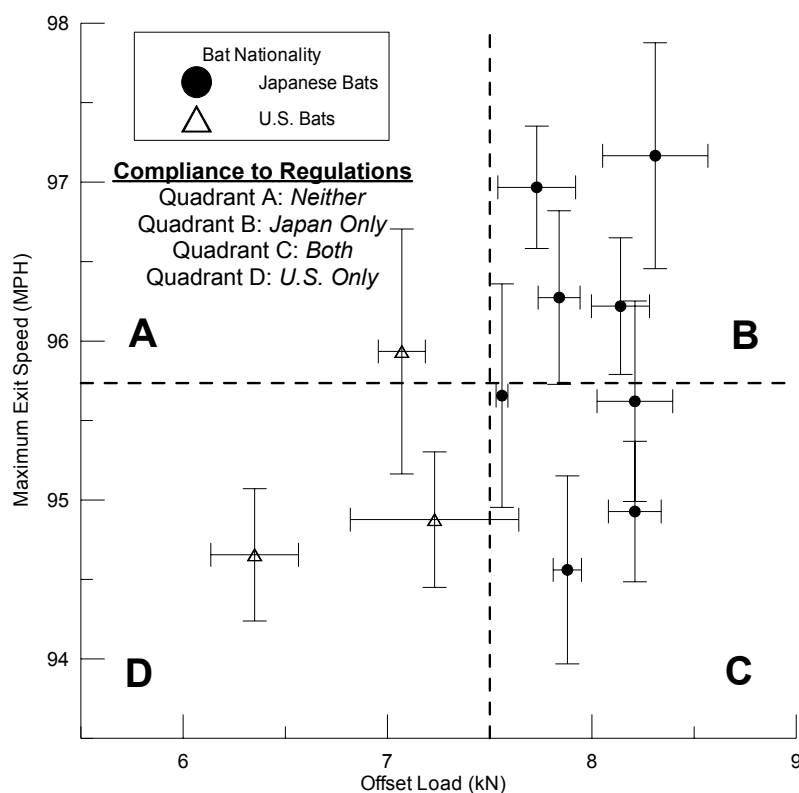
**Table 6: Offset loads of rings of U.S. bats**

<i>Bat ID</i>	<i>Ring ID</i>	<i>Offset Load (kN)</i>	<i>Average Offset Load (kN)</i>	<i>Average Wall-Thickness (in)</i>
<b>SN07</b>	<b>1</b>	6.78	6.35	0.111
	<b>2</b>	6.44		0.107
	<b>3</b>	5.84		0.101
<b>SN08</b>	<b>1</b>	6.86	7.07	0.114
	<b>2</b>	7.36		0.116
	<b>3</b>	7.00		0.108
<b>SN09</b>	<b>1</b>	6.49	7.22	0.112
	<b>2</b>	6.93		0.118
	<b>3</b>	8.26		0.122

#### 4.2.3 Overall Offset Load Comparison Results

Though Table 5 and Table 6 present the resiliency of each bat numerically, the tables are not adequate for investigating the correlation between the resiliency and the performance of the bats. Fig. 34 shows the relationship between the maximum exit speed of each bat and the offset load. The quadrants of Fig. 34 are separated by two limits; the BESR-based maximum exit speed limit and the lowest offset load requirement, and denote the compliance to the respective regulations. The results restate clearly that four of the eight Japanese bats performed within the BESR limit. None of the U.S. bats

passed the offset load requirement. Statistical certainty of these barrel compression test results are presented in horizontal error bars representing the standard error of the mean of offset loads. The statistical certainty of BESR performance test results are presented in vertical error bars, representing the standard error of the mean of exit velocities. Fig. 34 shows that the difference among the bats in maximum exit speed is greater for the bats with more than 7.5 kN offset loads than the bats with less than 7.5 kN offset loads. However, no clear correlation between maximum exit speed and offset load was found.



**Fig. 34: Performance distribution by offset load and ball exit speed**

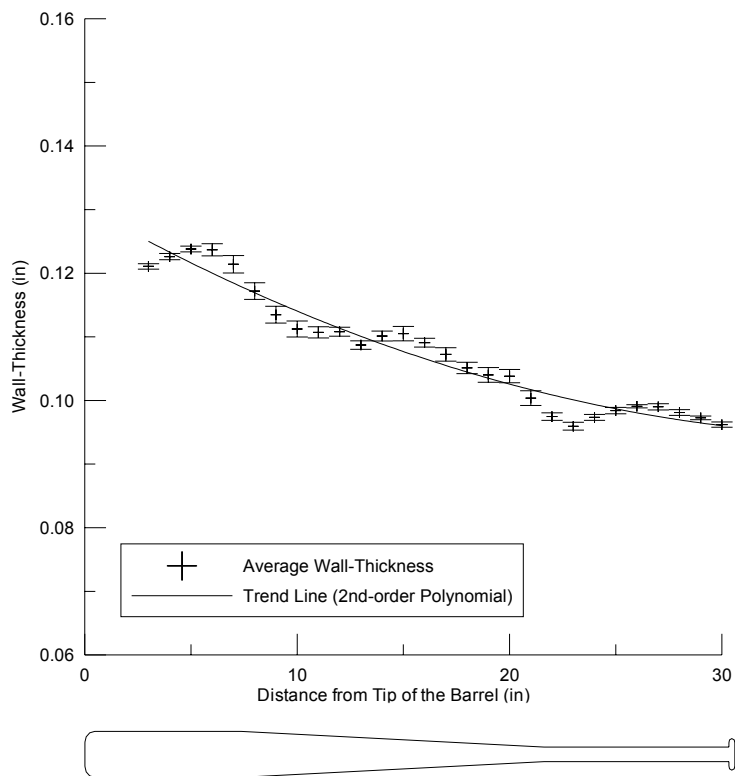
### 4.3 Wall Thickness Measurements

The results of wall thickness measurements on the bats performed by following the procedures mentioned in Section 3.4 are presented in this section. The raw data of the wall thickness measurements obtained from the ultrasonic thickness gage were based on C500 aluminum material, which was the material for none of the eleven bats. Therefore, the original measurement data had to be converted for the correct materials of the bats such as A7075 and A7050 by employing Eq. 8.

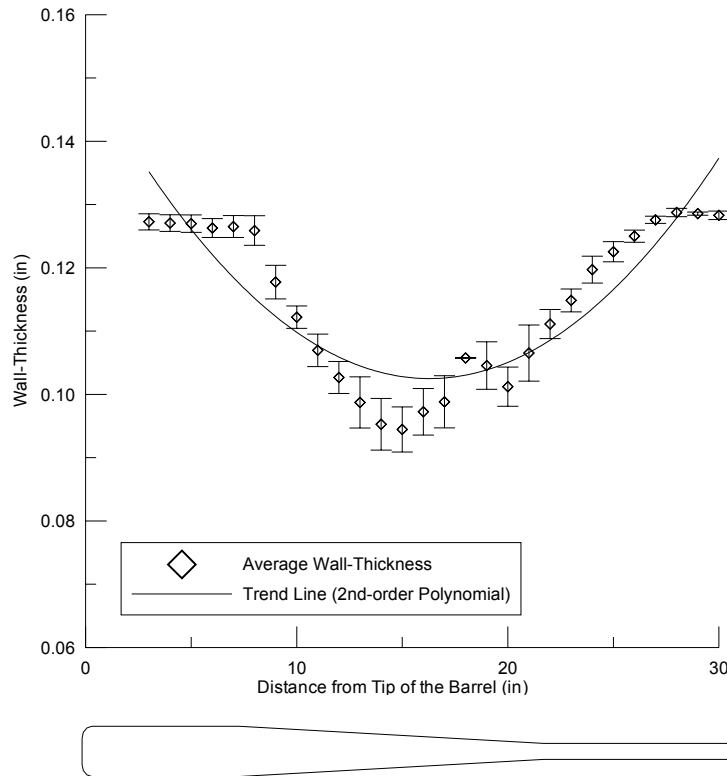
#### 4.3.1 Wall Thickness of Japanese Bats

The wall thickness distributions for the Japanese bats after the material-difference conversion are presented in Fig. 35 through Fig. 42. The error bars in the figures present the standard error of the mean of wall-thickness measurements. Unlike the other Japanese bats, as shown in Fig. 35, SN01, which was one of the best performing bats among the eleven bats, had a very characteristic wall-thickness distribution; having the thickest wall part at its barrel and then decreasing thickness in progressing to its handle. Fig. 36 shows that SN02 had a thin wall at its taper and had a relatively thick wall at its barrel and handle. The wall thickness of SN02 at its barrel was almost constant.



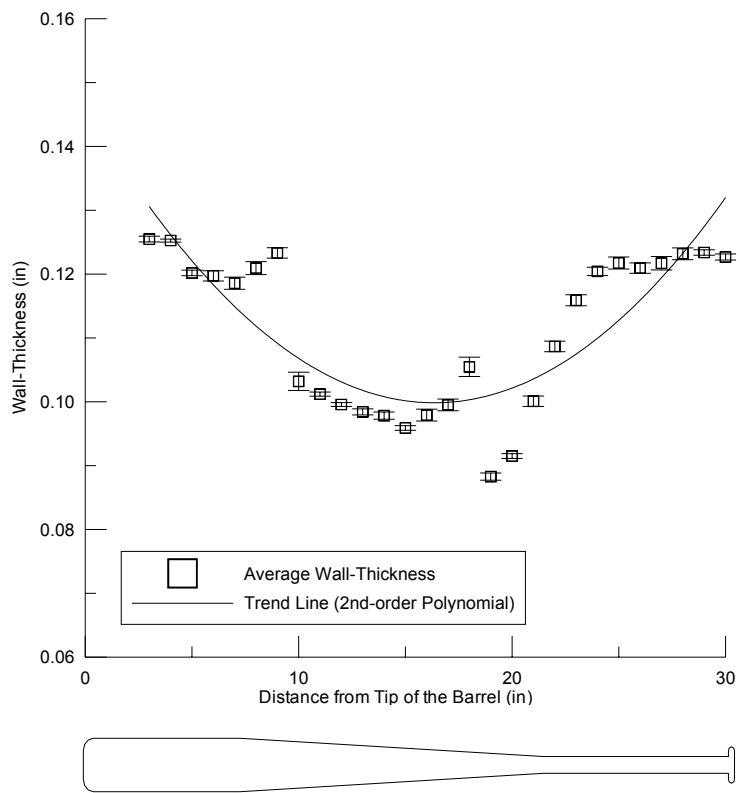


**Fig. 35: Wall-thickness distribution of SN01**

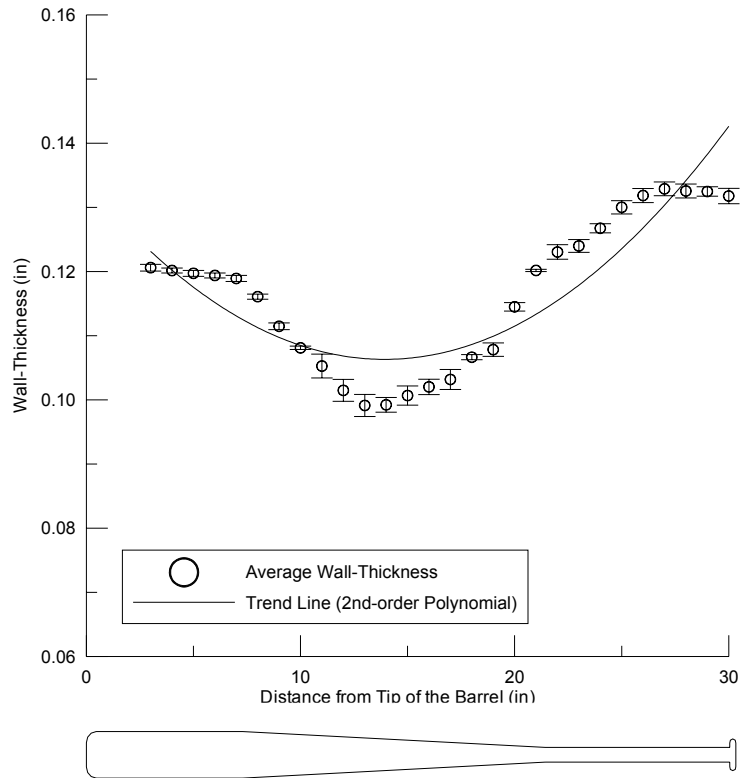


**Fig. 36: Wall-thickness distribution of SN02**

The wall-thickness distribution of SN03, as shown in Fig. 37, was atypical. The wall thickness was either constant or smoothly distributed in its barrel, taper, and handle. However, the smooth wall-thickness distributions changed abruptly at the border between the barrel and the taper and at the border between the taper and the handle. Unlike SN03, the wall-thickness distribution of SN04, shown in Fig. 38, was smooth. The trend of the wall thickness of SN04 was similar to that of SN02, but the wall thickness at the barrel and at the handle was slightly different in the case of SN04.

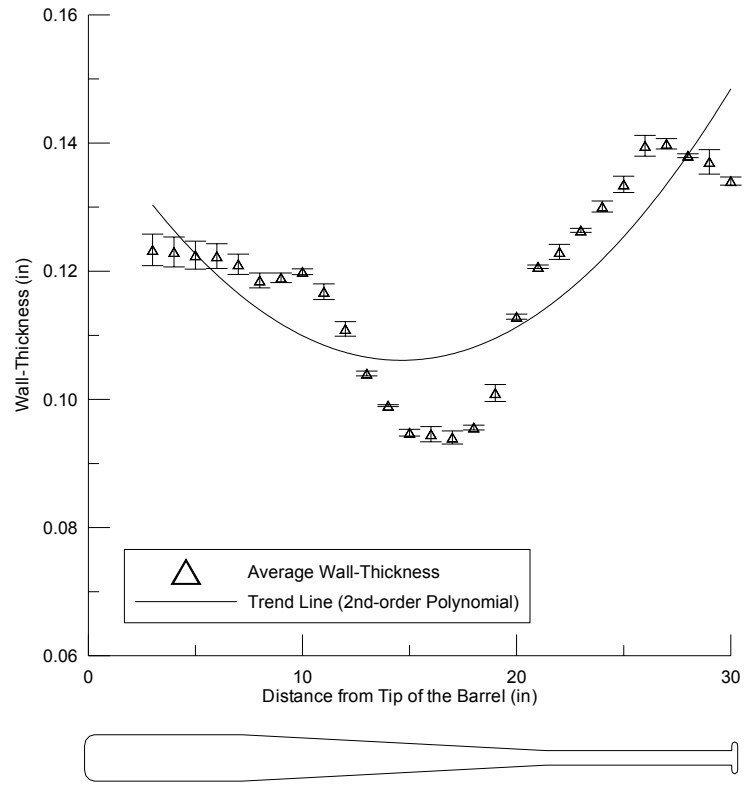


**Fig. 37: Wall-thickness distribution of SN03**

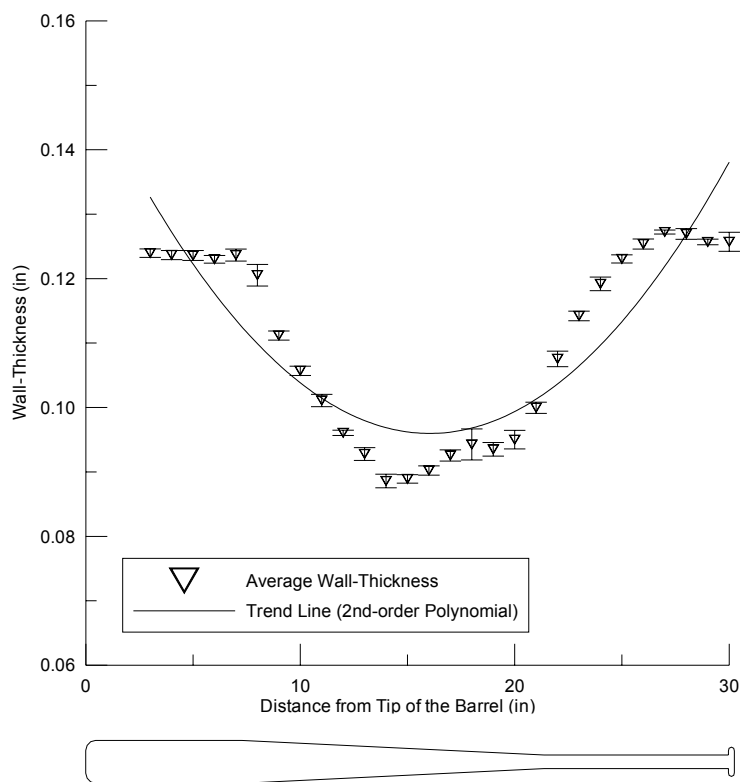


**Fig. 38: Wall-thickness distribution of SN04**

Fig. 39 presents the wall-thickness distribution of SN05. The distribution was similar to that of SN04. A noticeable difference between SN04 and SN05 was the wall thickness difference between the taper and the handle. SN05 had a thinner wall at its taper and a thicker wall at its handle than SN04. The wall-thickness distribution of SN06, shown in Fig. 40, was very similar and almost identical to that of SN02.

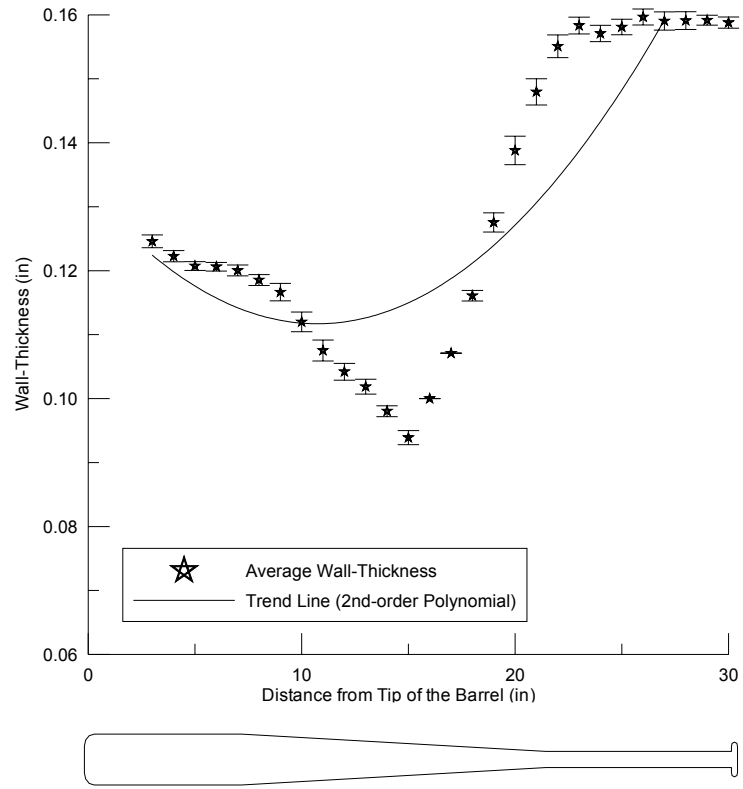


**Fig. 39: Wall-thickness distribution of SN05**

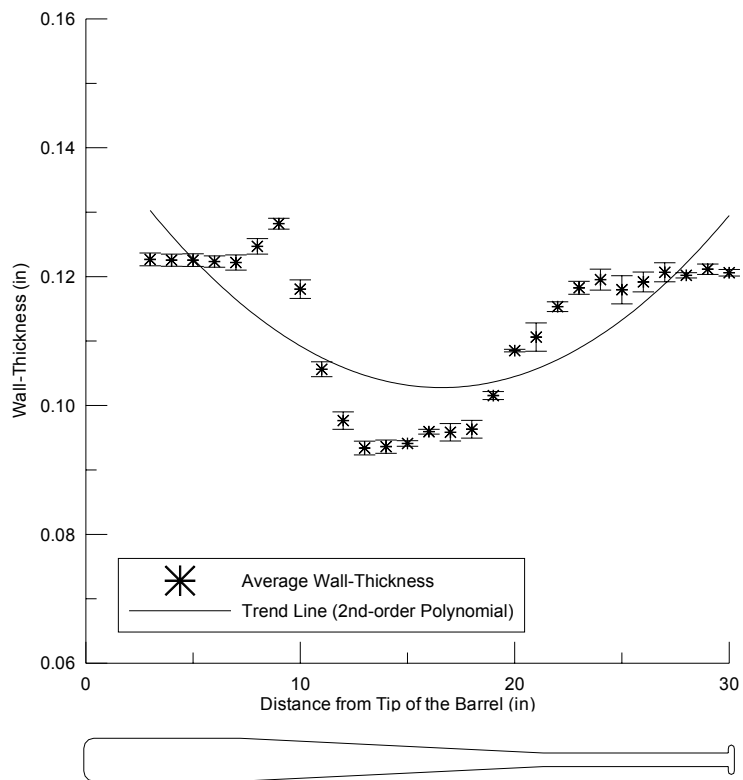


**Fig. 40: Wall-thickness distribution of SN06**

Fig. 41 shows the wall-thickness distribution of SN10. Like many of the Japanese bats, SN10 also had an almost constant wall thickness at its barrel and taper. However, the wall of the handle was much thicker than any of the other Japanese bats. Unlike SN10, SN11 had almost same wall thickness at its barrel and taper as shown in Fig. 42.



**Fig. 41: Wall-thickness distribution of SN10**



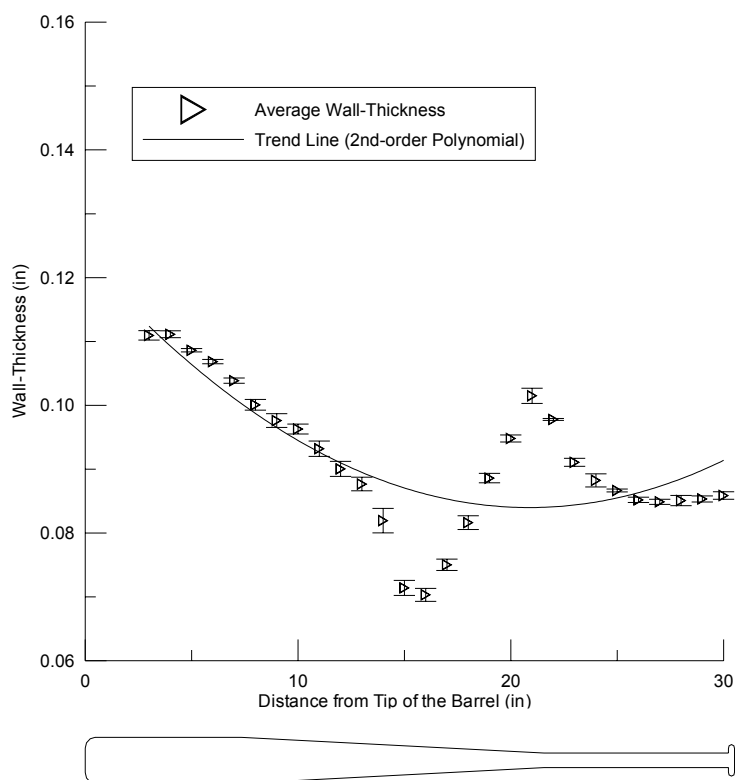
**Fig. 42: Wall-thickness distribution of SN11**

#### 4.3.2 Wall Thickness of U.S. Bats

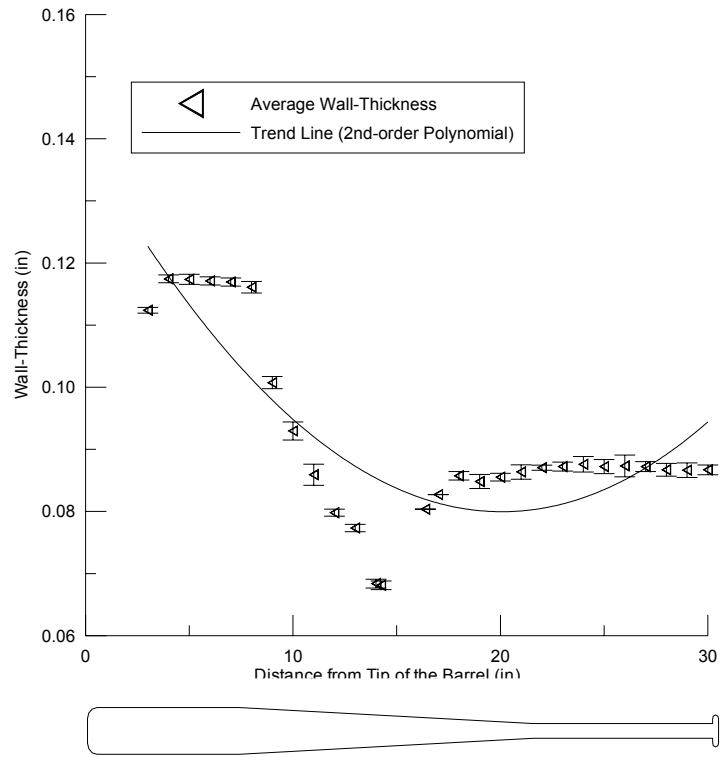
Fig. 43 through Fig. 45 present the wall thickness of the U.S. bats. Fig. 43 shows that the wall thickness of SN07 was not constant either at its barrel or at its taper. The wall thickness of the barrel decreased at positions closer to taper. The wall thickness at the taper of SN07 was very small, and wall thickness at the taper increased in progressing to the handle. In Fig. 44, there are no data points between the 14- and 17-inch positions because SN08 consists of two discrete parts, and the parts are connected with rubber between the 14- and 17-inch positions. Unlike SN07, the wall thickness of SN08 at its barrel and taper was uniform. SN08 also had the thinnest wall at the taper. As shown in Fig. 45, SN09 was the only bat that had a thicker wall in its taper than in its barrel and



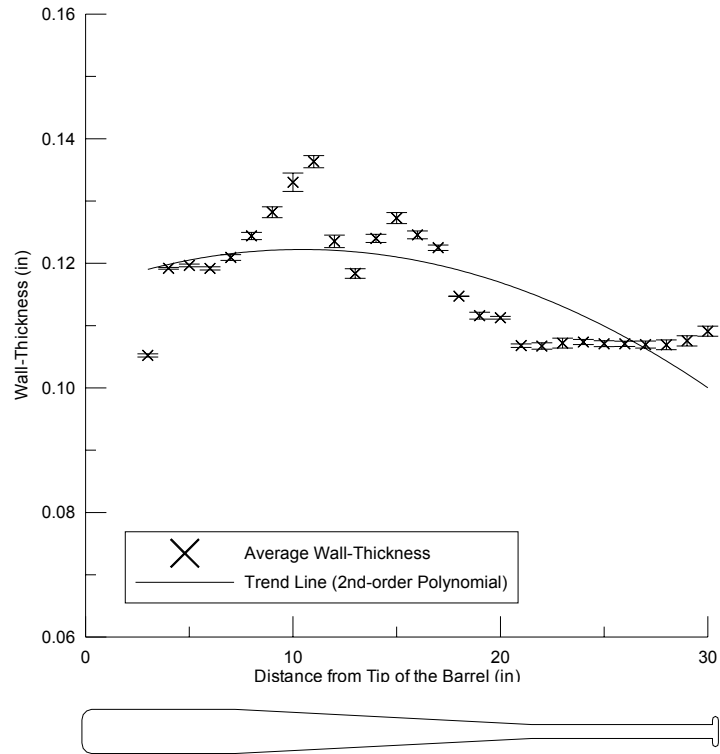
had the thickest wall at the border of its barrel and taper. Unlike the atypical wall thickness distribution at the barrel and the taper, the wall thickness at the handle of SN09 was uniform.



**Fig. 43: Wall-thickness distribution of SN07**



**Fig. 44: Wall-thickness distribution of SN08**



**Fig. 45: Wall-thickness distribution of SN09**

### 4.3.3 Overall Wall Thickness Comparison Results

Regardless of the nationality of the bats, the wall thickness distribution of the bats was similar to some extent. Most bats had the thinnest wall at their taper, and the wall thickness at the barrel and the handle was constant or nearly constant. However, it was obvious that SN07 and SN08 had thinner walls than the Japanese bats overall. Considering that none of the Japanese bats has as thin a wall as either SN07 or SN08 at the taper, it is possible to state that U.S. bats can have thinner walls at the taper because U.S. bats do not need to pass the wedge test, which is one of the requirements for the SG standard as mentioned in Section 2.2.2. Unlike the majority of the bats used in this thesis, neither SN01 nor SN09 had the thinnest wall at its taper and had thicker walls at the taper than at the handle.

From the wall-thickness measurement data, no prominent correlation between wall-thickness distribution and performance of bats was observed.

#### 4.4 Modal Test Results and Center of Percussion (COP)

In this section, results obtained from the modal tests and from the COP calculation, which were mentioned in Section 3.5, are presented. Table 7 presents the locations of node points of bats from the tip of barrel for first two modes, and Table 8 presents the locations of COP from the tip of barrel. For simplification, the barrel node of first mode is called “1st node”, and the barrel node of second mode is called “2nd node.”

**Table 7: Node point positions from tip of barrel for first two modes**

<i>Bat ID</i>	<i>Barrel Node of First Mode (in)</i>	<i>Barrel Node of Second Mode (in)</i>
<b>SN01</b>	7.063	5.063
<b>SN02</b>	7.063	5.188
<b>SN03</b>	7.063	5.063
<b>SN04</b>	6.844	5.313
<b>SN05</b>	6.938	5.188
<b>SN06</b>	7.000	5.156
<b>SN07</b>	6.313	4.781
<b>SN08</b>	6.563	5.063
<b>SN09</b>	7.000	5.063
<b>SN10</b>	6.500	4.625
<b>SN11</b>	6.625	4.938

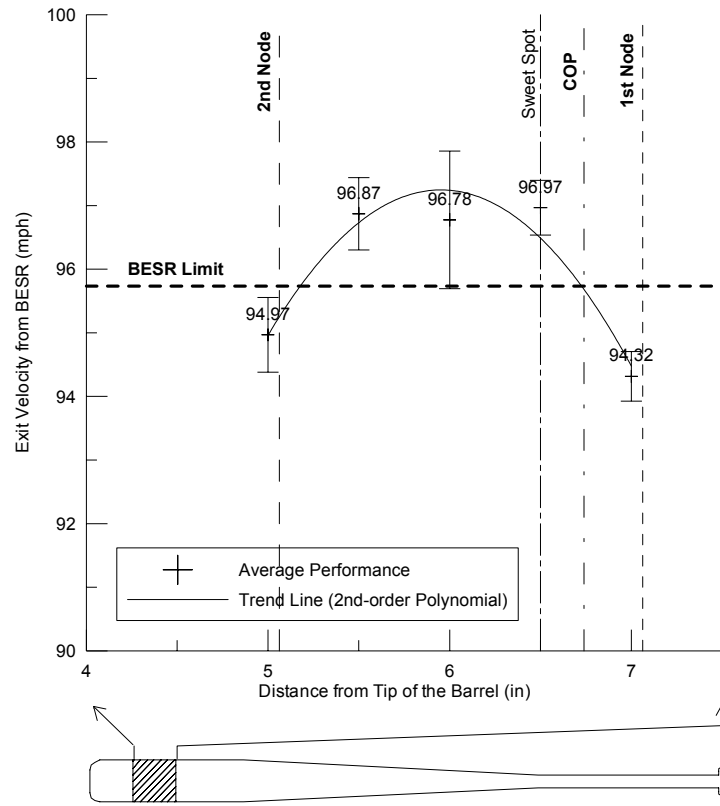
**Table 8: COP positions from tip of barrel of bat**

<b><i>Bat ID</i></b>	<b><i>COP (in)</i></b>
<b>SN01</b>	6.740
<b>SN02</b>	5.938
<b>SN03</b>	5.867
<b>SN04</b>	6.065
<b>SN05</b>	6.095
<b>SN06</b>	5.715
<b>SN07</b>	5.343
<b>SN08</b>	5.784
<b>SN09</b>	6.231
<b>SN10</b>	5.790
<b>SN11</b>	6.356

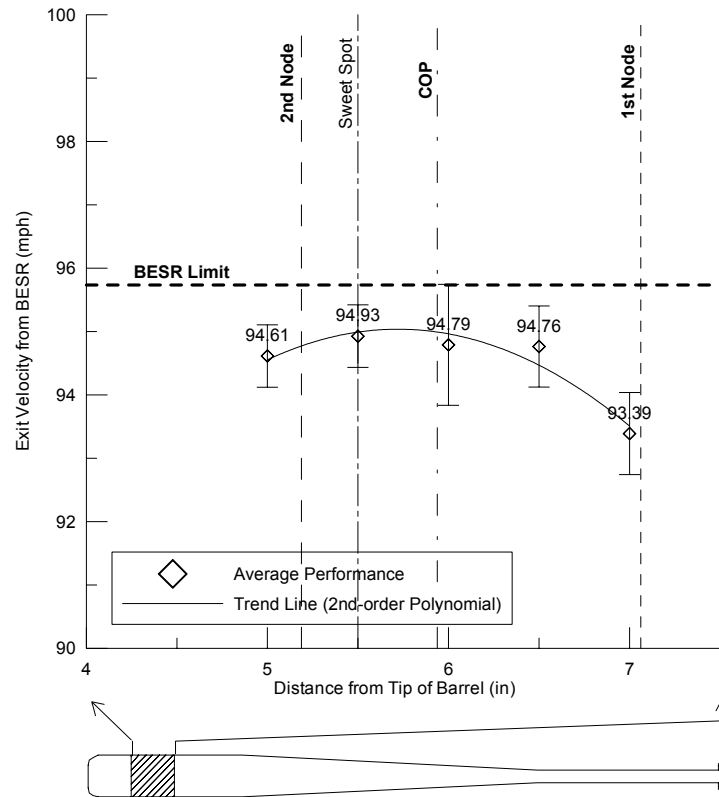
To investigate the relationship between performance and the positions of node points, COP, and sweet spots of the bats, the performance data figures were overlaid with the information about the positions as shown in Fig. 46 through Fig. 56.

#### 4.4.1 Node Points and COPs of Japanese Bats

Fig. 46 and Fig. 47 show the relationship between performance curves and the locations of the node points and the COPs of two Japanese bats. From Fig. 46, it was found that the locations of the COP, the 1st node, and the sweet spot were very close for SN01. Unlike SN01, the COP of SN02 was closer to the 2nd node rather than the 1st node.

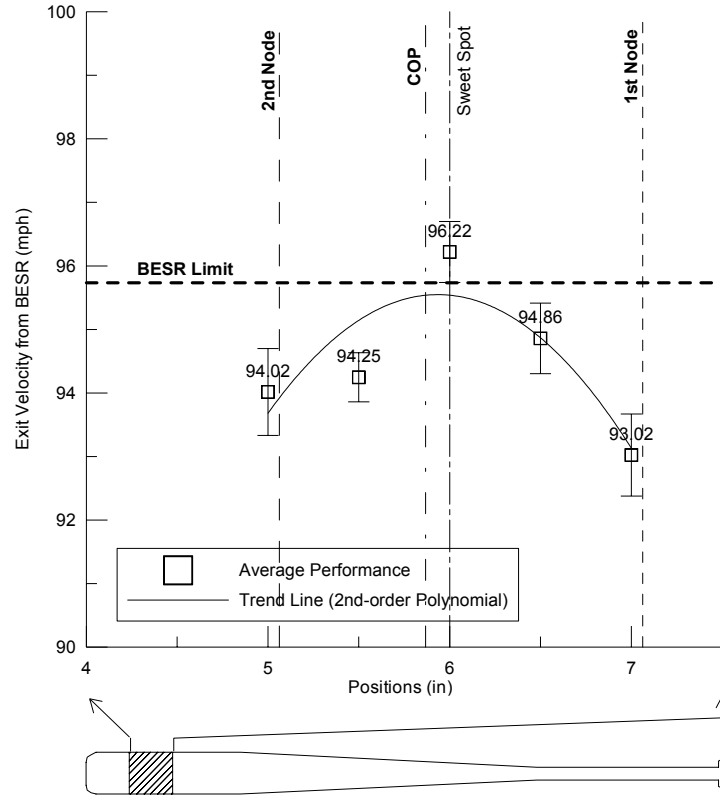


**Fig. 46: Node points and COP of SN01**



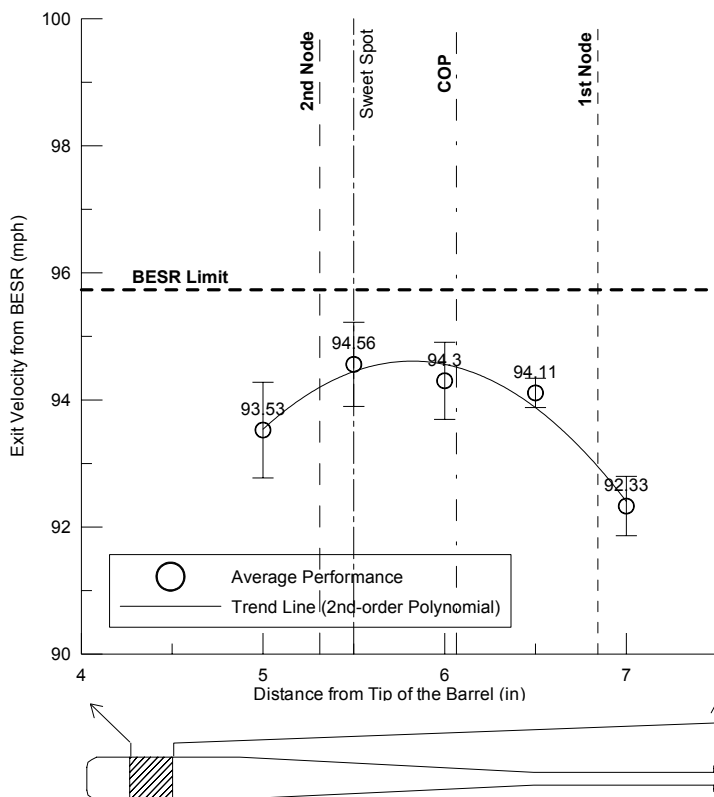
**Fig. 47: Node points and COP of SN02**

Fig. 48 and Fig. 49 present the locations of the node points and the COP in performance curves for SN03 and SN04, respectively. For SN03, the location of the COP was very close to its sweet spot. The COP of SN04 was located almost in the middle of the 1st node and the 2nd node.



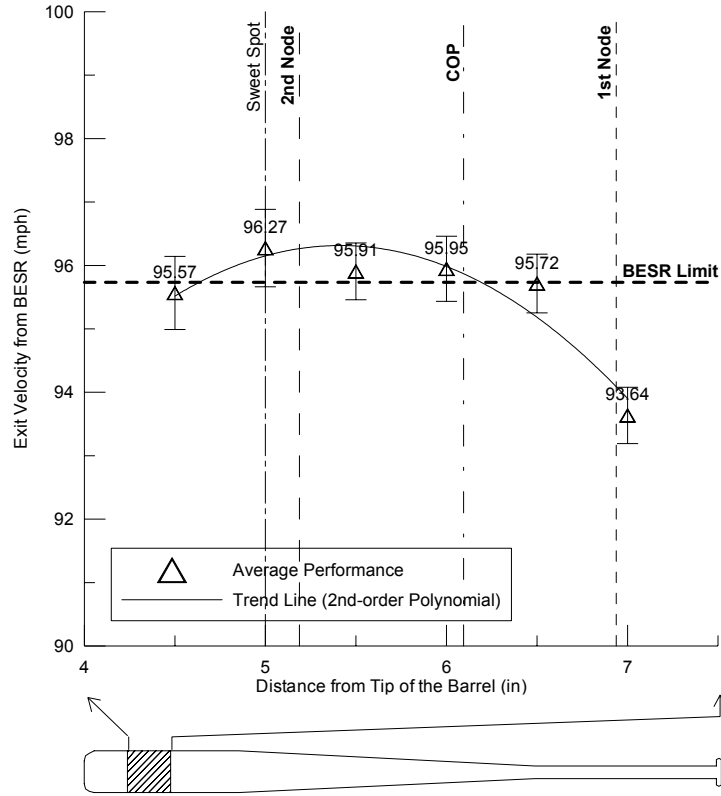
**Fig. 48: Node points and COP of SN03**



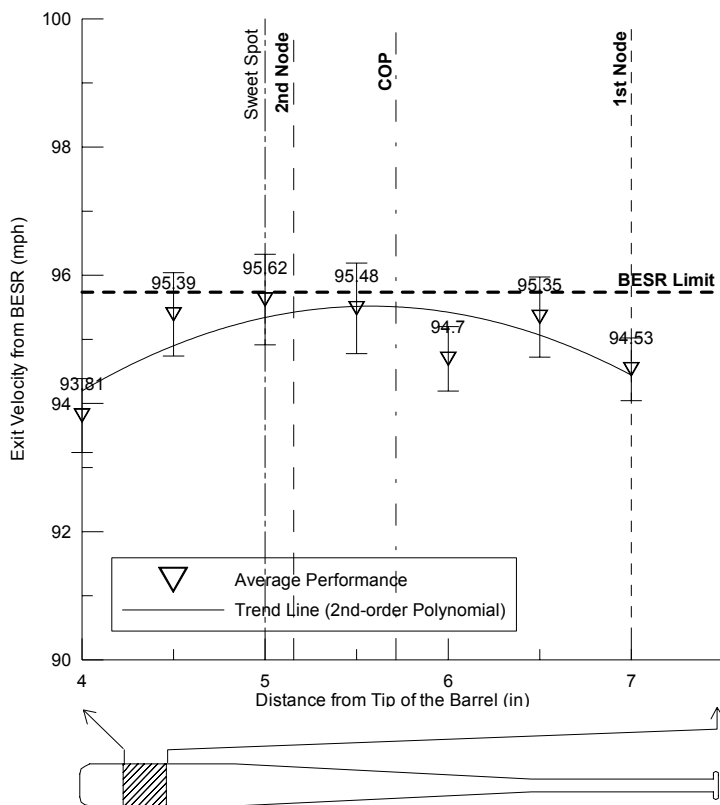


**Fig. 49: Node points and COP of SN04**

Unlike other bats, SN05 and SN06, shown in Fig. 50 and Fig. 51 respectively, did not have their sweet spots between the 1st node and the 2nd node. Both of the sweet spots were located slightly off the respective 2nd node of each bat. However, the trendlines for each of these bats implies that the sweet spot is between the 1st node and the 2nd node. Like SN04, the COP of SN05 was located almost in the middle of the 1st node and the 2nd node. However, SN06 had its COP close to its 2nd node.

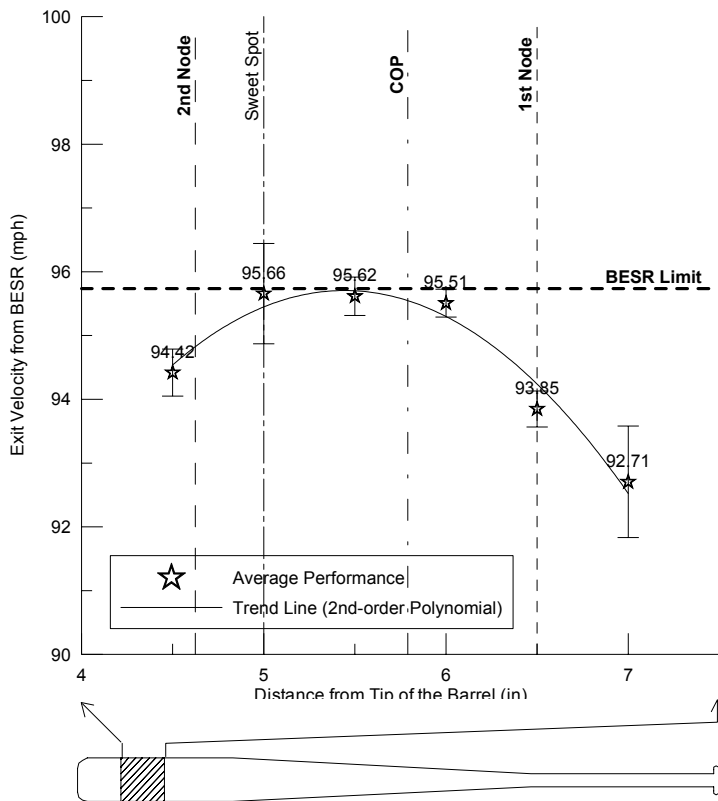


**Fig. 50: Node points and COP of SN05**

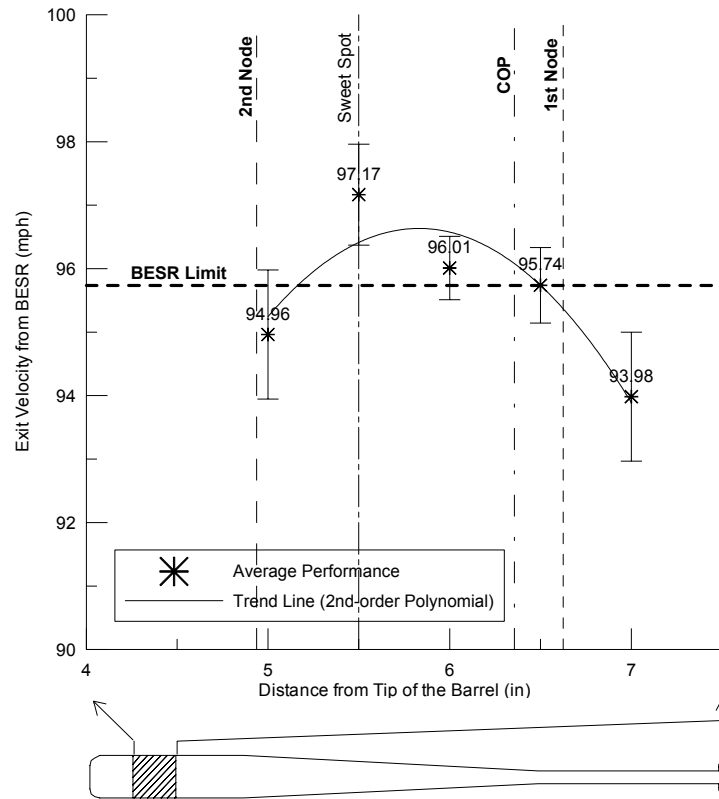


**Fig. 51: Node points and COP of SN06**

As shown in Fig. 52 and Fig. 53 respectively, the COPs of both SN10 and SN11 were located closer to the 1st node than the 2nd node of the respective bats. The distance between the COP and the 1st node of SN11 was almost as small as that of SN01, which had as high a BESR performance as SN11. The 1st node of SN11 was located between the 6.5- and 7.0-inch positions while that of SN01 was located outside of 7.0-inch position.



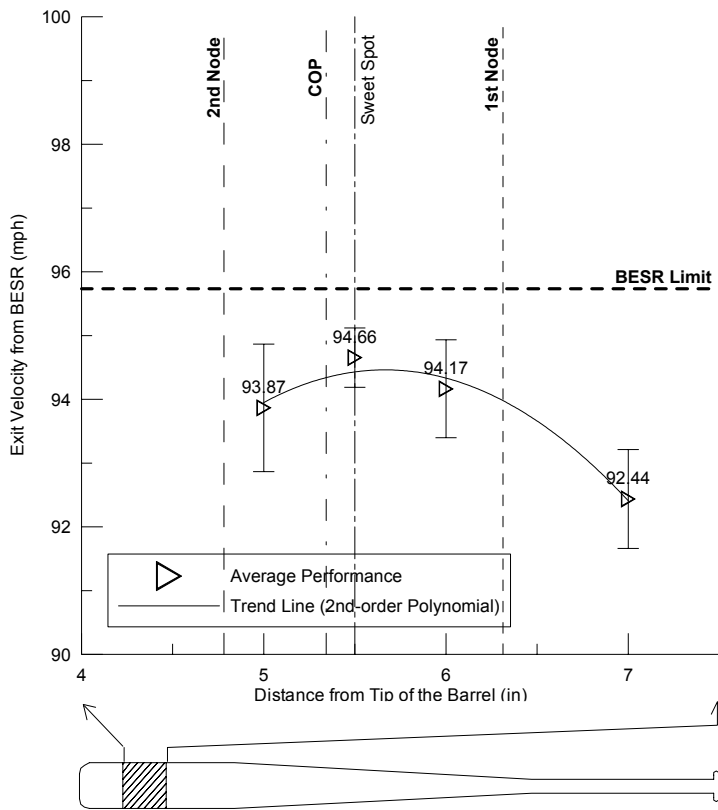
**Fig. 52: Node points and COP of SN10**



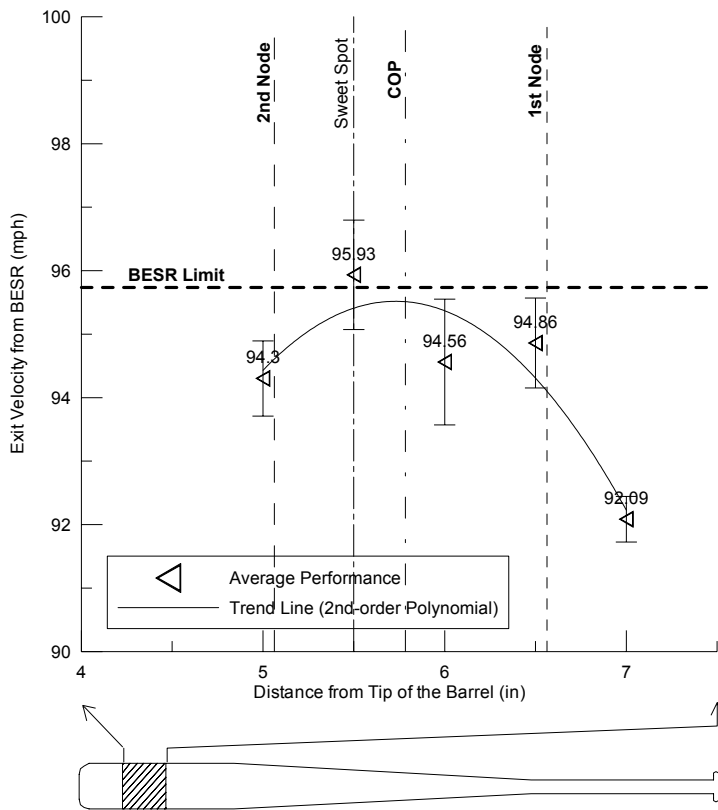
**Fig. 53: Node points and COP of SN11**

#### 4.4.2 Node Points and COPs of U.S. Bats

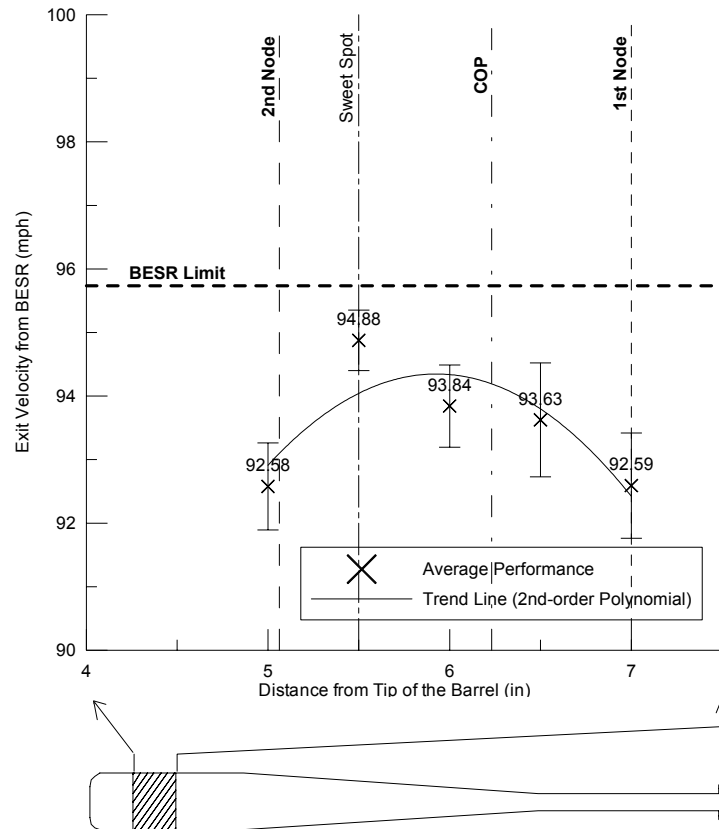
The locations of the node points and the COPs of the U.S. bats are shown in Fig. 54 through Fig. 56. The COP of SN07 was located closely to the 2nd node of the bat, and its sweet spot was close to the COP. In contrast, the COP of SN09 was close to the 1st node of the bat, and its sweet spot was not close to the COP. Unlike SN07 and SN09, the location of the COP of SN08 was in the middle of the 1st node and the 2nd node of the bat.



**Fig. 54: Node points and COP of SN07**



**Fig. 55: Node points and COP of SN08**



**Fig. 56: Node points and COP of SN09**

#### 4.4.3 Overall Node Points and COP Comparison Results

No correlation between performance and the positions of node points, COP, and sweet spots was observed from Figs. 46 through 56. However, SN01 and SN11, which were the best performing bat and the second best performing bat, respectively, among the eleven bats, had a clear characteristic that their 1st node and their COP were located very close together, within half an inch. The figures also imply that the location of the sweet spot of the bat, which is defined as the highest performance spot in this thesis, is not always coincident with the locations of the 1st node or the COP, which are considered as the sweet spot of the bat by some researchers and baseball players.



#### 4.5 Mass Moment of Inertia (MOI) Comparison

In this section, the results of the MOI comparison of the bats are presented. The MOIs of the bats are calculated by employing Eq. 2. In this thesis, unless specified otherwise, the MOI of a bat is the one about the axis 6-inch from the base of the knob of the bat. The position was selected because the MOI requirement under the NCAA standard utilizes the MOI value at the 6-inch position where baseball players hold the bat in their hands. The MOI for each bat is presented in Table 9.

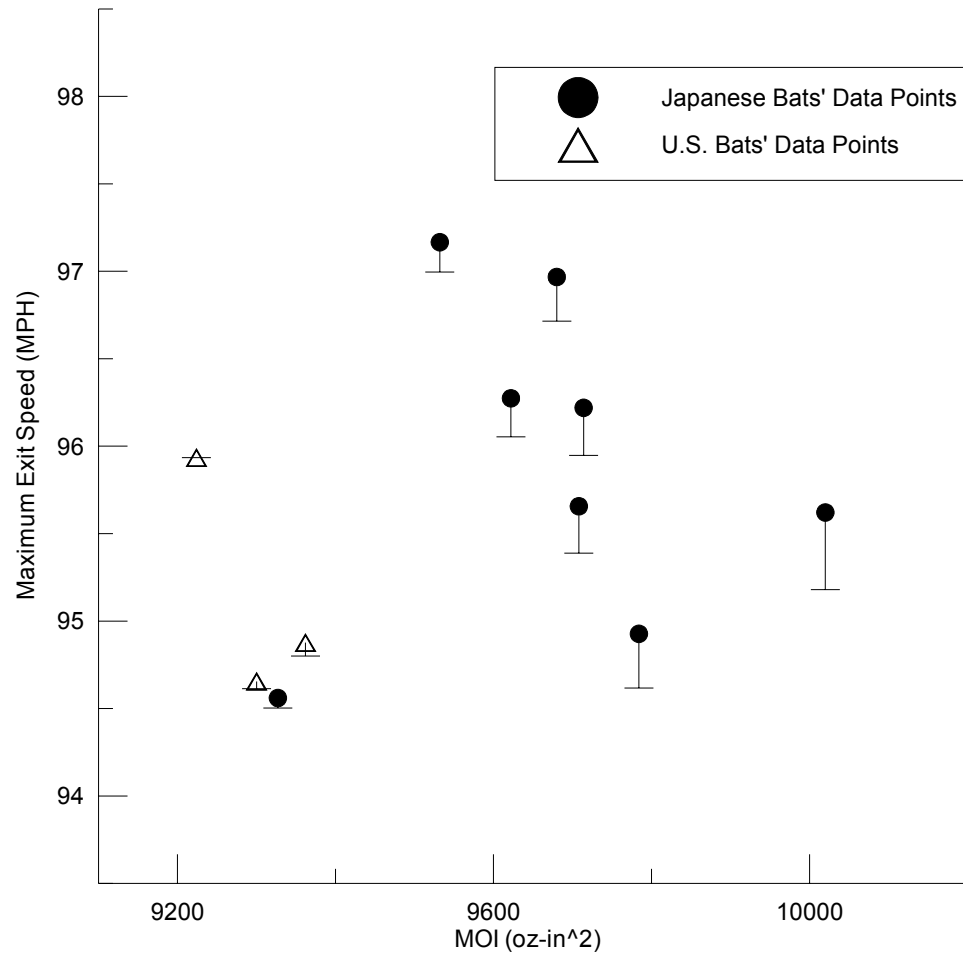
**Table 9 : MOI of the bats**

<i>Bat ID</i>	<i>MOI (oz-in<sup>2</sup>)</i>
<b>SN01</b>	9680
<b>SN02</b>	9784
<b>SN03</b>	9714
<b>SN04</b>	9327
<b>SN05</b>	9622
<b>SN06</b>	10020
<b>SN07</b>	9300
<b>SN08</b>	9224
<b>SN09</b>	9362
<b>SN10</b>	9708
<b>SN11</b>	9532

The data in the table provide adequate information for simply comparing the MOIs of the bats. However, for investigating the correlation between the performances

and the MOIs of the bats, the original maximum exit speed data obtained from the Baum Hitting Machine should not be viewed as representative of field performance of bats as mentioned in Section 3.1.3. Therefore, the effect on performance due to MOI differences must be included by employing Eq. 6 and Eq. 7. For the baseline MOI value to be used for calculating the MOI difference, the lowest MOI of the eleven MOI values was chosen, which was 9224 oz-in<sup>2</sup> from SN08. Because the changes in swing speeds were small, it was assumed that the BESRs remained essentially the same for the small changes in swing speed. The relationship between the maximum exit speeds and the MOIs of the bats including the effect of MOI difference is shown in Fig. 57. In the figure, error bars show the decrease in performance due to MOI normalization, and the solid circles and the open triangles denote the original maximum exit speed of the Japanese bats and U.S. bats, respectively.

After normalization, the Japanese bats did not show appreciable difference in maximum batted-ball speed performance from the U.S. bats. However, two Japanese bats, SN01 and SN11, still outperform the best performing U.S. bat in this study regardless of MOI normalization. There was no major correlation between maximum exit speed after MOI normalization, which denotes field performance of bat, and MOI.

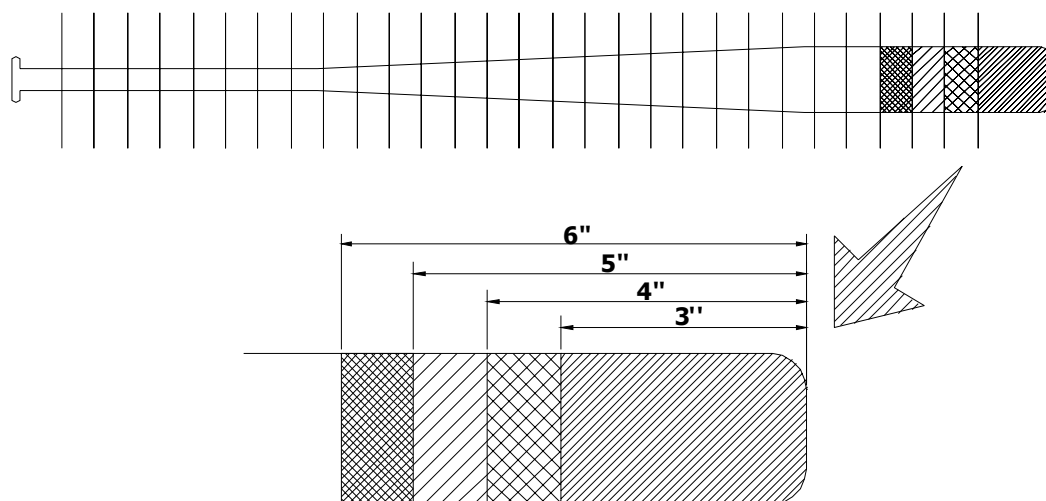


**Fig. 57: Relationship between performance and MOI with MOI normalization**

#### 4.6 Partial Weight Comparison

Partial weight comparison calculates the sectional weight of the bats and compares the differences in weight distributions to investigate if there exists any correlation between the weight distribution and the performance. In this work, the weight distribution was presented in two ways. One way is to show the sectional weight of the bat, which is the weight of an incremental section as discussed in Section 3.4. This method can be useful to compare the weight of bats by sections. For example, from the results obtained by this method, it is possible to find which bat has the heavier barrel.

The other way to present the distribution is to show the cumulative weight of the bats. The cumulative weight is calculated by adding the sectional weights. For instance, as shown in Fig. 58, the cumulative weight of a bat up to 6 inches from the tip of barrel would be calculated by adding the weights of the first 3-inch part from the tip of barrel ( $W_{0-3}$ ), an incremental section between the 3- and 4-inch positions ( $W_{3-4}$ ), an incremental section between the 4- and 5-inch positions ( $W_{4-5}$ ), and an incremental section between the 5- and 6-inch positions ( $W_{5-6}$ ).



The cumulative weight is:  $W_{cumulative} = W_{0-3} + W_{3-4} + W_{4-5} + W_{5-6}$

**Fig. 58 : Definition of “cumulative weight up to 6-inch position”**

The cumulative weight plot gives some insight into how the weight of the bats increases as the position progresses from the barrel to the handle. Because it was almost impossible to take the end caps out of the bats without damaging the end cap, the cap plus part of the barrel of the bat, as shown in Fig. 59, was utilized for estimating the weight of the first 3 inches from the tip of the barrel. The remaining sections were obtained after

the bats were cut into rings for the barrel compression tests. Table 10 presents the weight of the first 3-inch part of the bats including their end caps.



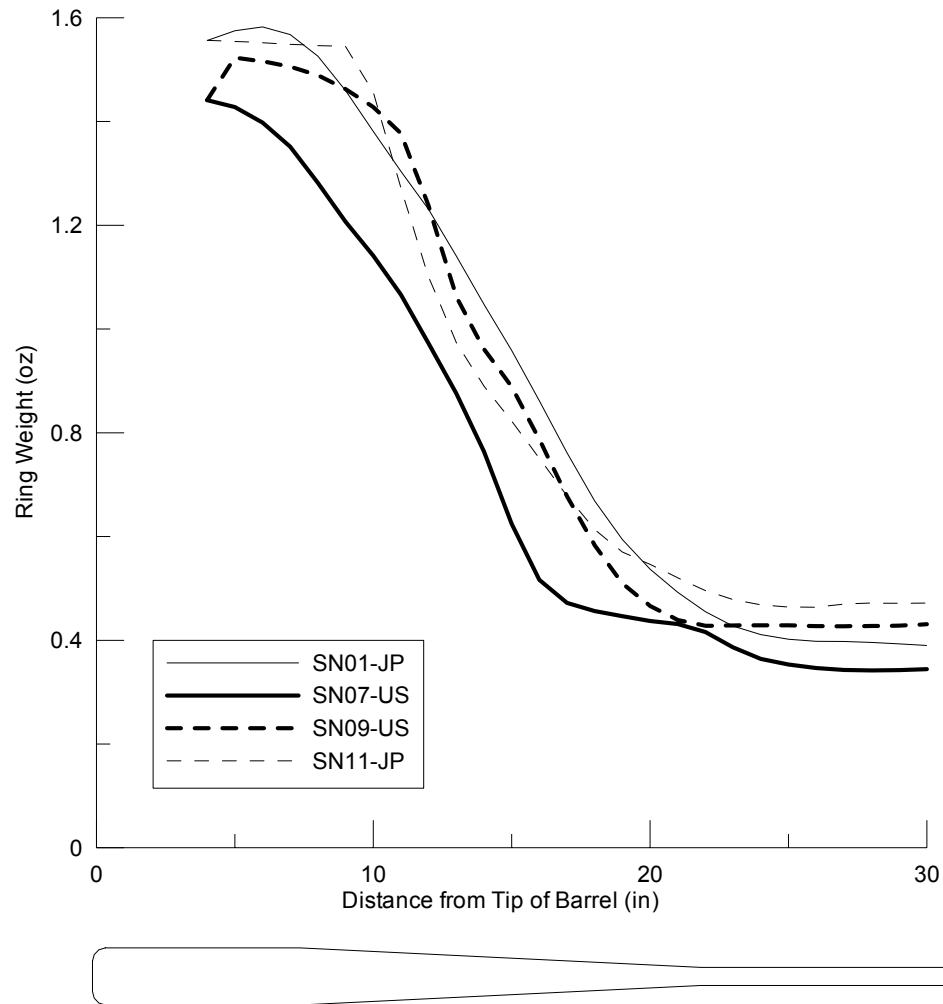
**Fig. 59: Barrel tips with end caps**

**Table 10: Weight of first 3-inches of the bats**

<i>Bat ID</i>	<i>Total (oz)</i>
SN01	5.318
SN02	4.957
SN03	5.197
SN04	4.779
SN05	5.261
SN06	5.209
SN07	5.116
SN08	4.785
SN09	4.526
SN10	5.595
SN11	5.379

#### 4.6.1 Partial Weight Comparison by Ring Weight

The relationship between ring weights and positions on the bat for all of the bats are shown in Appendix B. Unlike the data obtained from other tests and measurements performed in this study, there was no significant difference in ring weight distribution for the bats. Therefore, it was not practical to compare the data of all of these bats in one partial-weight-distribution figure. In comparison with presenting all data in one figure, selecting and presenting data of four or five bats in the same figure would be easier to investigate the correlation between the performance and partial-weight-distribution. There were a number of ways to select which of the bats to be compared. However, because the purpose of the partial weight comparison in this thesis was to explore whether any correlation exists between partial weight distribution and performance of bat, it was determined to select the bats with “extreme” performance: the two best performing bats and the two least performing bats. Among the eleven bats, the two best performing bats were SN01 and SN11, which were both Japanese bats, and the two poorest performing bats were SN04 and SN07. However, SN04 was not selected for the partial weight comparison because selecting SN04 would make the comparison “three Japanese bats against one U.S. bat”, which was not appropriate for achieving the objective of this thesis; the comparison of U.S. and Japanese bats. Therefore, the two best performing Japanese bats (SN01 and SN11) and two poorest performing U.S. bats (SN07 and SN09) were employed and compared for their ring weight distribution as shown in Fig. 60.

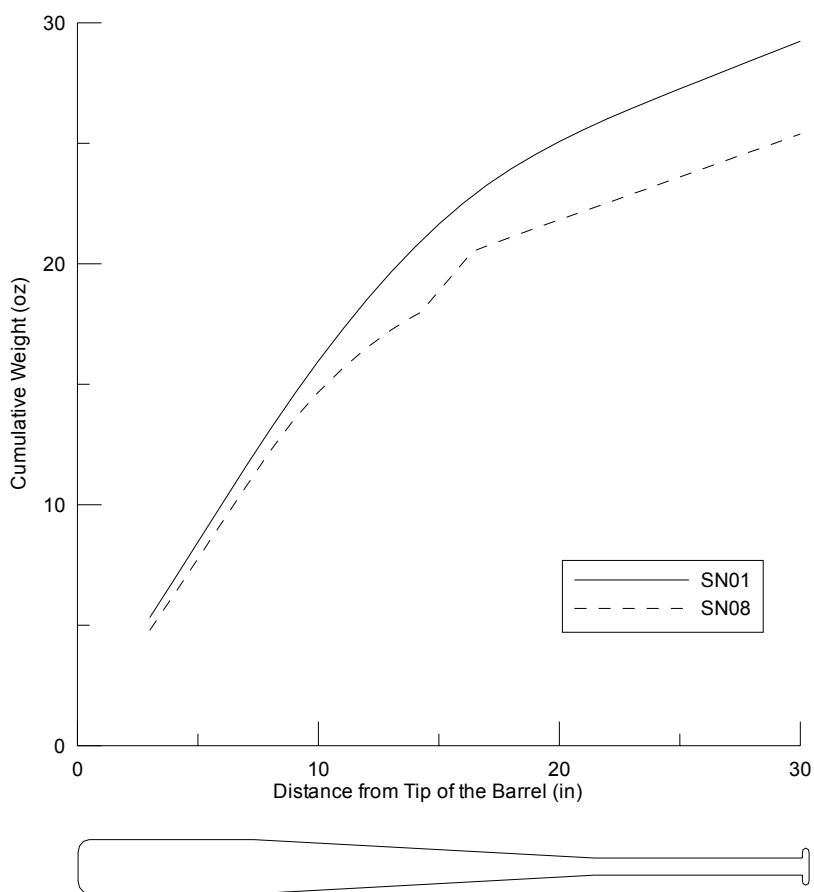


**Fig. 60: Comparison of ring weight distribution about positions on bats**

Fig. 60 shows that the partial weight of SN07 was noticeably lower than those of the other three bats at the barrel, taper, and handle. The barrels of the two best performing bats were slightly heavier than that of SN07 and much heavier than that of SN09. Among the four bats, SN11 was the only bat that had a barrel of uniform weight. All the bats had uniform weight at their handles.

#### 4.6.2 Partial Weight Comparison by Cumulative Weight

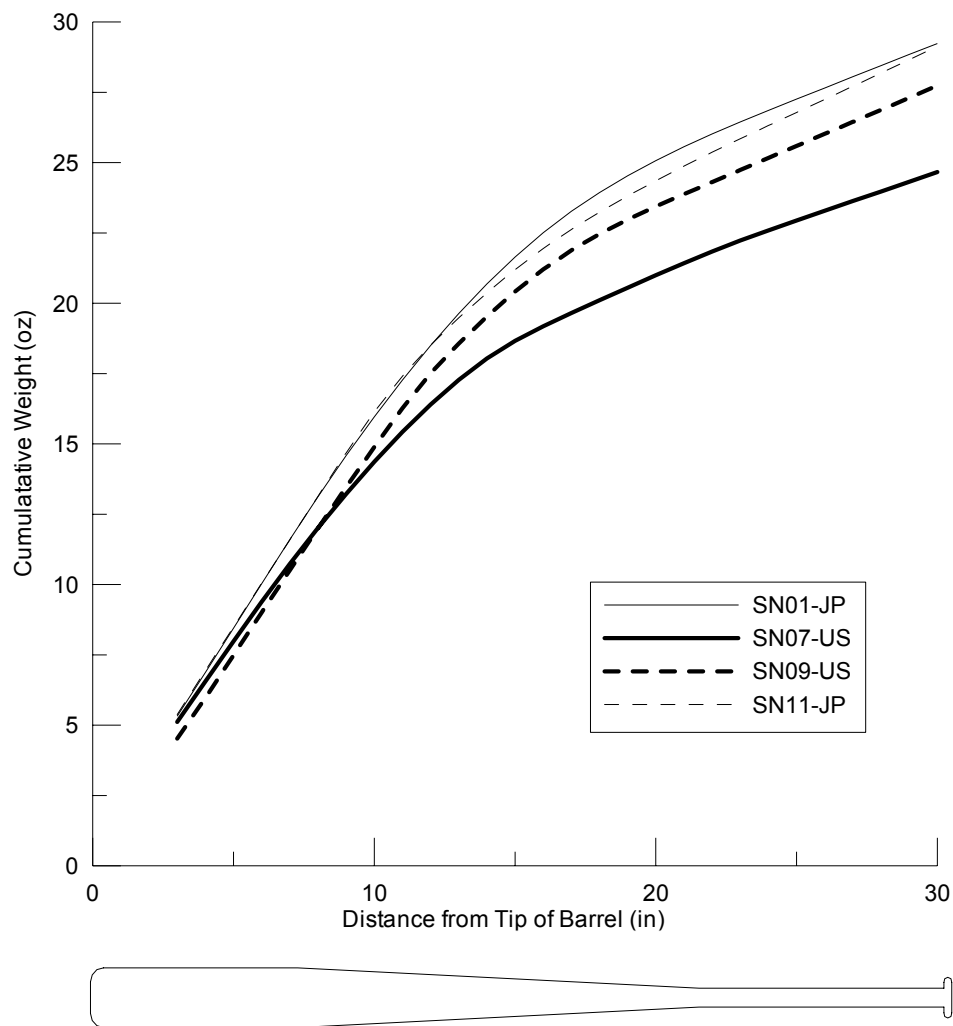
The cumulative weight distributions of SN01 and SN08 are shown in Fig. 61. The figure shows that the increase in weight decreases as soon as the distance from tip of barrel reaches 10 inches, which is the location where the taper section of the bat usually starts. The trend of SN01 was common to all of the bats except SN08. As shown in Fig. 61, the distribution of SN08 has a sudden “leap” at its taper because its barrel and taper are connected with a rubber ring. The cumulative weight distributions of the rest of the bats are presented in Appendix C.



**Fig. 61: Cumulative weight distribution comparison for SN01 and SN08**



Like the partial-weight comparison by ring weight, the differences among the bats in their cumulative weights were not appreciable. Therefore, it was not practical to compare the bats in the same cumulative-weight comparison figure. Fig. 62 presents the cumulative-weight distributions of the four bats, which were the bats employed in Fig. 60.



**Fig. 62: Cumulative weight distribution about positions on bat**

Fig. 62 shows that the two best performing bats, SN01 and SN11, had more weight in the barrel through the handle than the other two bats, SN07 and SN09. The

weight of the first 3-inch section of SN07 was very close to those of SN01 and SN11. Therefore, it is possible to conclude that SN07, SN01, and SN11 had end caps of similar weights.

#### 4.6.3 Partial Weight Comparison Results

In this section, the partial-weight distributions of bats were investigated by comparing the ring weights of the bats and by comparing the cumulative weights of the bats. The partial-weight distribution graphs obtained by the two methods for the eleven bats had very similar trends, and there was no clear difference in the figures. Fig. 60 and Fig. 62 showed the clear difference in the partial-weight distributions between one of the least performing bats and one of the best performing bats. However, no prominent correlation between performance and weight distribution was found.

#### 4.7 Overall Comparison Conclusion

Chapter 4 presented the results of the comparison of the eleven bats by utilizing the methods discussed in Chapter 3. The original BESR performance test data showed that the difference between the best performing bat and the poorest performing bat was more than 2 mph. However, the real performance difference after the MOI normalization was less than 2 mph. The results clearly showed that the two Japanese bats, SN01 and SN11, outperformed all three U.S. bats and the other six Japanese bats employed in this thesis. Though the performance differences between the two bats and the other bats were noticeable, no major differences in the static test data were observed.

## 5 CONCLUSIONS

In this thesis, the performances of U.S. and Japanese aluminum bats were compared by utilizing protocols established in the respective countries. Nonprotocol supplementary tests were also performed to investigate if any correlation exists between performance and static testing data, which include wall thickness, node points, COP, MOI, and weight distribution. The performance data obtained with the Baum Hitting Machine showed that four of the eight Japanese bats tested in this study outperformed all three of the U.S. bats. However, the other four Japanese bats performed within the BESR limit—similar to the U.S. bats. The average performance of the eight Japanese bats was about one mph greater than that of the three U.S. bats. The barrel compression test results showed a clear trend that all the Japanese bats had offset loads of more than 7500 N, and all the U.S. bats had offset loads of less than 7500 N. However, no clear correlation between performance and offset load was found. The supplementary tests also did not show any major correlation between dynamic performance and static testing data. It is possible to conclude that the Japanese regulation is controlling the performance of aluminum bats fairly well in spite of the lack of direct restriction on batted-ball performance using a dynamic test method.

## 6 RECOMMENDATIONS

There are three recommendations for the further development in the comparison study of baseball bats from the two countries.

The first recommendation is to investigate the stiffness of the end caps of the bats. The results from the barrel compression test performed in this thesis indicated the resiliency of the barrel of the bat quantitatively. However, not only the aluminum barrel part should be investigated, but the end cap of bat may also play an important role in determining the “actual” resiliency of the bat, which potentially affects the performance of the bat. Therefore, investigating the stiffness of end cap could provide insight into the differences in bat performance.

The second recommendation is to increase the number of samples. In this thesis, eleven aluminum baseball bats, eight Japanese bats and three U.S. bats, were tested. However, the bats were different models, and it was not possible to consider the performance difference in the same model due to manufacturing variations. Therefore, testing more than a single bat for each model would give the study some statistical significance.

The last recommendation is to analyze the performance trend of bat by considering the “effective length” of barrel of the bat, which means the length of the barrel where diameters are almost uniform. The BESR protocol specifies that the performance test starts at the 6-inch position from the tip of the barrel of the bat, and this

specification implies that the protocol is made based on an assumption that the sweet spot of the bat is at or near the 6-inch position. However, this assumption may not always be applicable because the “trampoline effect” may be most prominent at the center of the effective barrel, and its location is not always at the 6-inch position on the bat. Therefore, to investigate the performance trend of the bat accurately, testing the performances at the center of the effective barrel of the bat and the near the center would be appropriate.

## 7 LITERATURE CITED

- The Baseball Hall of Fame and Museum (2003). "The Entrants for the Baseball Hall of Fame in 2003." 25 September. (in Japanese)  
<http://www.baseball-museum.or.jp/corner4/corner4.htm>
- Hutchens, Mark H. (1998) "Head Injuries in Baseball." Injuries in Baseball. Ed. James R. Andrews, Bertram Zarins, and Kevin E. Wilk. Philadelphia: Lippincott-Raven. pp392.
- Ohnishi, Tadakazu (1997). "Broken Metal Bats – Lack of Strength because of Performance-oriented Design." Nikkei Mechanical 511: pp29-31. (in Japanese)
- Ohtsubo, Yasumi (1999). "Protect Pitchers! – Bat Restriction Faces Trade Barrier." Mainichi Newspapers 23 February. (in Japanese)  
<http://www.mainichi.co.jp/entertainments/sports/99senbatsu/tousyu/0223.html>
- "A Pitcher Was Killed in a Batted-Ball because Coaches Did Not Correct His Pitching Form. His Parents Sue the High School." (2003). Yomiuri Shimbun 23 April. (in Japanese)
- NCAA. "NCAA Division I Baseball Statistics Trends (1970-2002)".  
[http://www.ncaa.org/stats/baseball/trends/1/1970-2002\\_d1\\_trends.html](http://www.ncaa.org/stats/baseball/trends/1/1970-2002_d1_trends.html)
- Kinkai, Takashi (2002). "Wooden Bats Come Back to Company League Baseball." Kobe Shimbun 27 April. (in Japanese)  
[http://www.kobe-np.co.jp/news\\_now/news2-126.html](http://www.kobe-np.co.jp/news_now/news2-126.html)
- "Rule Revision to Make Metal Bats to Perform Less." (2001). Sponichi Annex 6 February. (in Japanese)  
<http://www.sponichi.co.jp/baseball/kiji/2001/02/07/10.html>

Sherwood, James A. (2000). "Reconsideration of Minimum MOI Summary." Report to NCAA, 19 October.

Lerner, L.S. (1996). Physics for Scientists and Engineers. Jones and Bartlett Publishers Inc., Boston. pp. 308-309

Drane, Patrick J. (2003). "Characterization of the Effects of Use and Moisture Content on Baseball Bat Performance Using Experimental Methods." 11 March.

Tokieda, Kenichi (2003). Personal communication by e-mail. 9 April.

Fleisig, G.S., Zheng, N., Stodden, D.F. and Andrews, J.R. (2002). "Relationship between bat mass properties and bat velocity". *Sports Engineering* 5.

"Science of Baseball Activity: Minimizing Handle Force" (2004)."  
[http://www.exploratorium.edu/baseball/handle\\_forces.html](http://www.exploratorium.edu/baseball/handle_forces.html)

## APPENDIX A

### **NATIONAL COLLEGIATE ATHLETIC ASSOCIATION PROVISIONAL STANDARD FOR TESTING BASEBALL BAT PERFORMANCE**

September 27, 1999

[The following protocol has been adopted by the NCAA and must be followed when baseball bats are submitted for certification. This protocol has been adopted as an addendum to NCAA baseball rules and does not supersede the rules. In short, NCAA Baseball Rules must be followed.]

#### **Certification Protocol**

##### **Initial Written Notification**

To initiate the certification process for all baseball bats that are constructed with materials other than one-piece solid white ash, an interested bat manufacturer must send the NCAA written notice of its intent to conduct certification testing on specific models it deems appropriate for testing. The notice to conduct testing must contain a detailed description of all models to be used in NCAA competition, the date of first production, the model number, the bat length and weight combinations of each model to be manufactured, the maximum diameter, the handle diameter, location of the center of gravity (balance point), the nominal wall thickness of the barrel and of any other part of the bat with a wall thickness that differs from the barrel, the ultrasonic setting used to determine wall thickness, and the materials (e.g., alloys, composites, any filling or deadening materials) used to make the product (including, without limitation, any materials used inside the bat and the materials composing and/or contained in the bat's end cap). Such information shall not be confidential, and shall be available on request. In addition, an 8" x 10" color photograph of each model to be certified shall be provided to the NCAA. At that time, the NCAA will provide the manufacturer with a testing reference number, e.g. NCAA-1999-0001, in writing, and only those bat models will be cleared for testing.

##### **Certification Process**

The NCAA then will require that a manufacturer supply a minimum of two typical bats of every length class (per Table 1), weight class (per Table 2), and model combination for certification to James A. Sherwood, University of Massachusetts at Lowell, James B. Francis College of Engineering, Department of Mechanical Engineering, One University Avenue, Lowell, Massachusetts 01854 (978/934-3313, james\_sherwood@uml.edu). Dr. Sherwood and his research team will conduct the certification tests as stated in the testing protocol on one of the bats for each length, weight and model combination. All bats of each particular combination which are sold or otherwise provided for NCAA play by the manufacturer must meet the specifications of the new standard in order for that combination to be certified for NCAA competition. If approved, the NCAA will provide



written confirmation for each approved combination bat and will issue a certification number for each approved combination bat.

Table 1. Length classes for bats

<b><u>Length Class (In.)</u></b>
32.0 -0.25/+0.24
32.5 -0.25/+0.24
33.0 -0.25/+0.24
33.5 -0.25/+0.24
34.0 -0.25/+0.24
34.5 -0.25/+0.24
35.0 -0.25/+0.24

Table 2. Weight classes for bats without grip

<b><u>Weight Class</u></b> <b>(Unit difference, weight from length)</b>
-3.00 to -2.10
-2.09 to -1.10
-1.09 to -0.10

A mandatory silk-screen or other permanent certification mark shall consist of the phrase "BESR Certified" and must be clearly displayed on the barrel end of the bat. The manufacturer may use the certification mark in descriptive materials (such as catalogs) to identify bats that comply with this testing standard, but may make no other use of the mark. Use of the certification mark to advertise or promote the sale or distribution of bats is expressly prohibited. There shall be no charge for the use of the certification mark in accordance with this protocol.

In the event that all bats submitted for testing become damaged and unusable for testing, the manufacturer will be notified by the Certification Center and requested to submit at least two more bats for certification. The certification of that length, weight and model combination will then go to the next open position in the certification queue, i.e. end of the line, upon receipt of the new bats.

All bats will be returned except for the tested bat(s) and one for record purposes. The retained bats will be stored in a secure area and only Certification Center personnel will have access to the secure area. The manufacturer will be assured that the confidentiality of its bat is protected.

### **Test Results**

Dr. Sherwood will simultaneously provide the NCAA and the manufacturer in writing with the test results of each length and weight combination for each model submitted by the manufacturer for certification. If a bat is submitted for testing by a sponsor other than the manufacturer, Dr. Sherwood will provide the test results in writing to the NCAA and

the sponsoring party. If a bat submitted by a sponsor other than the manufacturer fails the certification test, copies of the test results will also be provided in writing to the manufacturer.

Copies of all *confidential* data sheets will be supplied to the NCAA and to the test sponsor for every hit. If a bat that has been submitted for testing by a sponsor other than the manufacturer fails the certification test, copies of all confidential data sheets will also be supplied to the manufacturer. The original data sheets will be filed in hard copy and digital form at the Certification Center and in digital form at a secure off-site location. Information on the data sheet belongs to each test sponsor (and the manufacturer, if the test sponsor is not the manufacturer and the bat fails the certification test), for internal purposes only and shall be kept confidential by the certification center and the NCAA unless otherwise provided herein. The NCAA will retain the right to announce publicly that a bat has failed the certification test.

Manufacturers may, at their discretion, disclose the results, including test data, of testing on bats that they have manufactured. If a manufacturer discloses such information, however, the NCAA may make any additional disclosure of information from the same test that it deems appropriate.

### **Testing Expenses**

All of the expenses to conduct the testing at the University of Massachusetts at Lowell Baseball Research Center will be funded by the manufacturer or test sponsor for which certification testing will be conducted. All manufacturers should deal directly with Dr. Sherwood regarding the testing expenses.

### **Implementation Timeline**

Beginning January 1, 2000, only baseball bats that display an official NCAA certification mark on the barrel-end of the bat signifying compliance with the NCAA's bat performance standard will be allowed in regular-season and post-season competition. Solid white ash bats will be allowed for NCAA competition.

### **Compliance with the Performance Standard**

The NCAA will conduct discretionary periodic testing of certified baseball bats at its expense to ensure compliance with the standard. This testing is intended to fairly sample the bats used in NCAA play at the time of the testing. Bats will be obtained from both dealer stock and field service. If any nonconforming bats are identified, the NCAA will notify the manufacturer in writing of its findings. A bat length, weight and model combination will not be declared nonconforming unless three different bats with that length, weight and model combination have failed the certification test. The manufacturer will be given the opportunity to review the compliance report and will be allowed an appeal in writing of the findings to the NCAA Baseball Rules Committee within fourteen (14) days upon receipt of the notice of findings. This right to appeal shall include a right to retest the bat or bats in question at the manufacturer's expense, and the results of any retest shall be simultaneously provided to the manufacturer and the NCAA. Once any retesting is complete, the rules committee will act on the appeal and notify the

manufacturer of its decision within seven (7) days. The rules committee shall disallow any bat for regular-season or post-season competition that does not meet the standard.

### **Manufacturer Right to Submit a Competitor's Bat for Compliance**

Manufacturer A is permitted to submit Manufacturer B's bat for testing and A pays for the testing regardless of outcome. If B's bat does not comply, then the Certification Center will notify the NCAA and the NCAA will take appropriate steps for noncompliance as described above. The same appeal procedures as described above shall apply in this circumstance, and the test sponsor shall be entitled to the results of any retest and appeal. The results of the test (including all test data) will be shared with the NCAA and the test sponsor in the manner described above. If the bat fails the certification test, the test results will also be shared with the manufacturer.

### **Penalty for Modification of Bat after it leaves the OEM**

A manufacturer will not be held responsible for noncompliance in the event that an aftermarket party alters the bat in any manner. The NCAA will deal directly with the team that collaborated with the aftermarket party. The manufacturer should make a best effort to produce a tamperproof bat, e.g. no screw-on endcap.

## **Testing Protocol**

### **Bat Preparation Procedures**

1. Measure and record model, length, weight and location of balance point.
2. Draw impact lines and axis line.
3. Measure and record diameter at 3", 4", 5", 6", 7", 8" and 9" from the tip of the barrel and 8" from the base of the knob.
4. Drill safety-pin hole at 1-7/16" from the base of the knob.

### **Mounting in the BHM**

Mount in grip, lock with safety pin 1-7/16" from base of the knob such that the rotation axis is 5-7/16" from the base of the knob, and align axis of bat with ball center. The grip material will be astroturf. The grip material will be uniform from test to test, and no set of grip material will be used for more than 8 hours of continuous testing. The grip material will be allowed to relax for a minimum of 8 hours before being reused.

### **Bat-Swing and Ball Pitch Speeds**

Input target speeds of  $66 \pm 1$  mph for the bat swing speed (velocity measured at a point 6 inches from the barrel end) and  $70 \pm 2$  mph ball speed to yield a combined speed of  $136 \pm 3$  mph. The tolerance on individual input speeds is to allow for test variance on a dynamic hitting machine (Baum Hitting Machine).

### **Torque Cutoff to Coast**

The torque supplied to the bat by the servo is cutoff 12.8 inches prior to impact. This torque cutoff ensures that the bat is coasting through the bat/ball collision as opposed to being powered through the collision. This 12.8-in. specification is accomplished by using

a pot value of 0.32 in the servo-control program, where each 0.01 of pot setting equates to 0.4-in. Therefore, because the bat speed may vary from test to test, the coast time will likewise vary from test to test, but the coast distance is fixed to be 12.8-in.

### **Determination of a Valid Hit**

For a reading to be valid, ball exit speed as measured at the 72" speed-gate location must be less than the higher of the speeds as measured at the 9" and 13" light-cell positions. The pitch speed must be within  $\pm 2$  mph and the swing speed must be within  $\pm 1$  mph of their respectively prescribed values. The combined speed must be within  $\pm 3$  mph of its prescribed value.

The bat speed on the datasheet is measured at the impact location. This impact location is not always at the 6-inch position on the bat. Therefore, the swing speed to conclude whether or not the hit was valid needs to reflect the appropriate speed at the point of contact for a swing speed of 66 mph at the 6-inch location. The following formula calculates the ideal swing speed at the point of contact:

$$V_{contact} = 66 \cdot \frac{(Length - 5.375 - Location)}{(Length - 11.375)}$$

Where  $V$  is bat speed at the 6-inch location,  $V_{contact}$  is the bat speed as recorded on the test datasheet,  $Length$  is the overall length of the bat, and  $Location$  is the hit location, e.g. 6.5-inch, or 7.0 inch, etc. A valid swing speed must be within  $V_{contact} \pm 1$ .

The ball must pass through the exit hole and not be too far left or right or high or low. The target is 62-1/16 in. from the impact point. The target is a diamond with equal diagonals of 13-in, i.e. a square, as shown in Fig. 1. One diagonal is horizontal and parallel to the bat axis. Three strings hang in the target for judging ball position manually. One string hangs from the top center of the diamond and extends to the horizontal diagonal. Parallel strings hang  $\pm 2$  in. on either side of the centerline string. If a ball hits the left string, then it is described as being "*too far left*". If a ball hits the right string, then it is described to be "*too far right*". If the center of the ball is judged by the test operator to be  $>2$  in. below the horizontal centerline of the target, then it is described as "*too low*". If the center of the ball is judged by the test operator to be  $>2$  in. above the horizontal centerline of the target, then it is described as "*too high*".

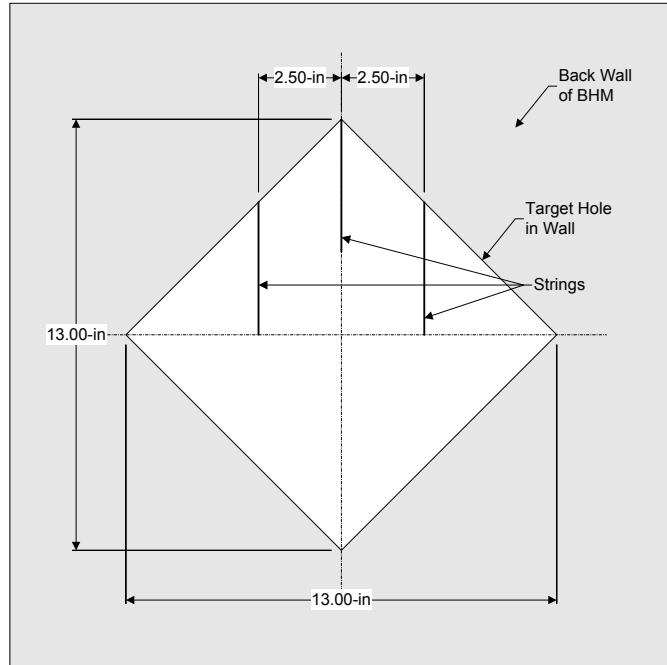


Fig. 1 BHM Target Window

### Exit-Velocity Readings and Impact Location

All bat positions are measured with respect to the distance from the tip of the barrel. Raw data exit velocities are to be recorded with testing commencing at the 6" point. Bat profiling will continue with hits at the 5", then the 7" points. If deemed necessary for certification purposes, bat profiling will continue at the discretion of the certification personnel with hits at additional points by using 1" and/or 0.5" increments. Five (5) consecutive valid exit-velocity readings are to be recorded at each of the bat-axis impact locations. Consecutive valid readings will be determined without regard to any interspersed invalid readings; thus, for example, three valid readings, followed by an invalid reading, followed by two valid readings will be considered five consecutive valid readings. The total number of hits may vary from bat to bat.

The ball exit speed ratio (BESR) is defined by:

$$BESR = \frac{\left( v^* - \frac{(V - v)}{2} \right)}{(V + v)}$$

where  $v$  and  $v^*$  are the ball entry and exit speeds, respectively, and  $V$  is the bat entry speed (this is the speed at the 6" point on the bat). Therefore, the measured bat input speed should be adjusted accordingly to reflect the bat input speed at the 6" point by use of the formula:

$$V = V_{contact} \cdot \frac{(Length - 11.375)}{(Length - 5.375 - Location)}$$

Where  $V$  is bat entry speed at the 6-inch location,  $V_{contact}$  is the bat entry speed as recorded on the test datasheet,  $Length$  is the overall length of the bat, and  $Location$  is the hit location, e.g. 6.5 in. or 7.0 in.

This relationship will be used to normalize the data with respect to bat and ball input speed variations. The BESR shall be the average of five valid readings at the point of maximum velocity as discussed above. At the point of maximum exit velocities, an average of 5 valid hits is used to conclude legality. If at anytime during the certification process the average of 5 consecutive valid hits exceeds the limiting BESR, then testing is halted and the bat is concluded to be illegal for NCAA competition. [Note: The wood bat standard will be based on at least three valid hits at each of the three above impact locations.]

The NCAA is continuing to study the issue of work-hardening in nonwood bats. At this time, the protocol will not contain specifications that attempt to address the issue of work-hardening, and none will be enforced before Aug. 1, 2000. However, if research reveals solid evidence related to this phenomenon, the protocol may be changed in the future in an effort to take the effects of work-hardening into account in the certification process.

The nonwood bats will be randomly rotated prior to each hit. The wood bats will be rotated 180 degrees prior to each hit according to standard wood bat usage, i.e. label up and label down. Alignment of the bat will be checked before each hit.

#### **Length-to-Weight Unit Differential**

The length-to-weight unit differential of each nonwood bat shall not exceed three units without the grip. Each length-class and weight-class combination of a particular model must be certified for compliance.

#### **Bat Surface**

The surface of the bat tested for certification must be the same as that of the production bat model which it represents and may exclude graphics.

#### **Bat Diameter**

The barrel diameter shall be no greater than 2.625 inches. A certified bat ring (no more than 1/4-inch thick) with an interior diameter of 2.657 inches must pass completely over the length of each bat prior to each hit. If the ring fails to pass over the entire length of the bat, then the bat is concluded to be illegal for NCAA competition.

#### **Balance Point**

There is no specification for the center of gravity, a.k.a. the balance point. However, the balance point will be recorded.

#### **Baseball Specifications**

The ball shall have a weight of  $5.12 \pm 0.035$  oz. The circumference of the ball shall be  $9.05 \pm 0.05$  in.

In a lot of 144 baseballs, six (6) will be randomly selected and tested to ensure that ball compression is no greater within a reasonable range than the compression characteristics of balls used in previous testing during August and September, 1999. If any one ball fails to meet this compression standard, then the entire lot is concluded to be unusable for certification testing. The six (6) balls tested will not be used for bat testing.

All baseballs to be used for certification will be tested on the BHM and the exit velocity will be recorded. The balls will be hit on the logo panel with the 6-in. point of a 34/31 Baum AAA Pro bat with a 2.5" diameter and a mass moment of inertia greater than 680 lb-in<sup>2</sup> at (70±2 mph pitch)+(68±1 mph swing speed @6" point)=138±3 mph. Baseballs for certification testing must fall within the acceptable exit velocity range (94±1.5 mph).

The initial BESR standard was generated using the Rawlings R100 NCAA ball, which qualified to a nominal speed of 94 mph using the standard bat at 70/68. In the event that the baseball is changed to a nominal speed other than 94 mph by some amount  $x$ , then the BESR will be recalculated using the wood-bat database where the batted ball speeds will be adjusted by this amount  $x$ , e.g.

$$BESR = \frac{\left( (v^* + x) - \frac{(V - v)}{2} \right)}{(V + v)}$$

$X$  will have a negative value if the nominal speed drops below 94 mph.

If new balls are utilized in future testing, the characteristics of those balls will be taken into consideration to ensure that no bat or type of bat is disadvantaged by the change in balls. Testing of balls to recalculate the maximum BESR shall be performed utilizing Baum bats of the same model and with the same characteristics described above. A change in BESR resulting from a change in balls shall not render previously compliant bats noncompliant. Any such change shall not materially alter the margin of compliance for compliant bats.

### **Ball Impacts**

Each of the test baseballs used during certification tests will be impacted a maximum of eight times (two sets of impacts on four opposite panels). Hitting will commence with the logo panel.

### **Bat Preparation**

Bats will be brought to laboratory environment temperature prior to testing.

### **Baseball Preparation**

Baseballs shall be stored in the laboratory environment for at least 24 hours prior to testing. Baseballs shall be stored in airtight containers. The balls shall be weighed again just prior to testing. Baseballs must meet the weight and circumference specifications in order to be used.

**Laboratory Environment**

The temperature in the testing lab shall be  $75\pm 10^{\circ}\text{F}$  and a relative humidity of  $45\pm 15\%$ .

**Manufacturer Attendance**

Manufacturer attendance is optional. Outside observers representing the organization that submitted the bat for testing may be present, but must follow the directions of the certification operators.

**Pass-Fail Criteria**

1. The bat must meet the size and weight specifications.
2. There are no tolerances for length-weight ratio (no greater than three units without the grip) or maximum barrel diameter.
3. The bat ring must pass over the entire length of the bat before and after every hit.
4. The ball exit speed ratio (BESR) as determined from the average of 5 consecutive valid hits at the maximum velocity location as described above must not exceed the stated BESR limit.
5. The bat's BESR must be less than .728 (which corresponds to 97 mph).

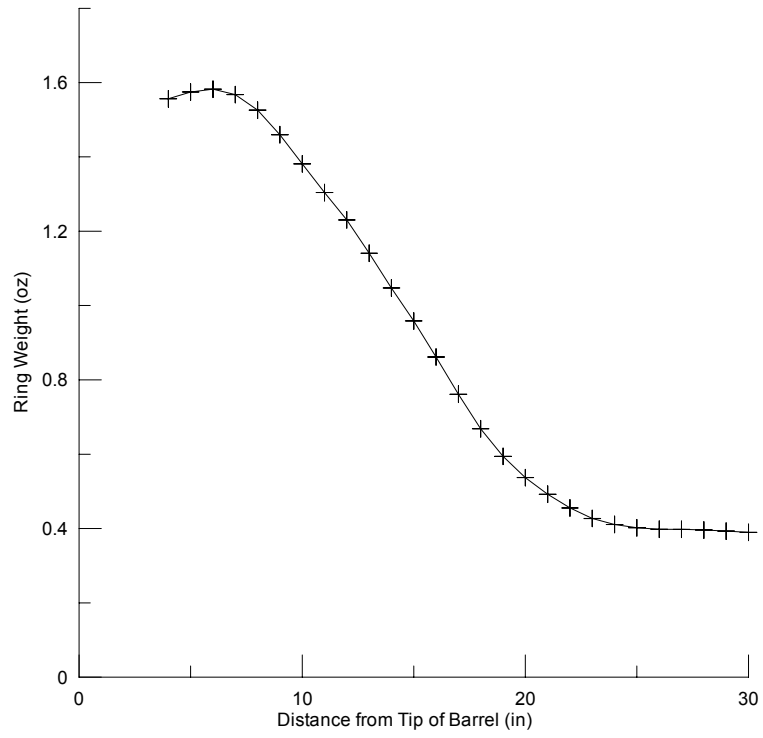
**Revisions**

The NCAA will revise the protocol as needed and reserves the right to change the test equipment, test location and the testing personnel. Any change in the protocol shall not be utilized prior to August 1, 2000 to prohibit the use of any previously certified bats.

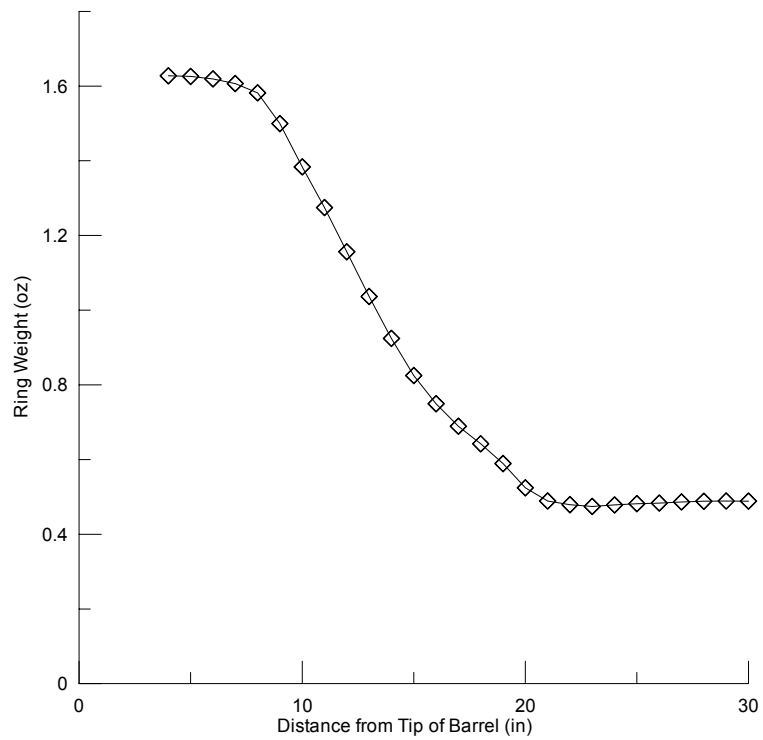
The NCAA will make every effort to make any future changes to the rule or protocol well in advance of any baseball season, which would be affected by that change.



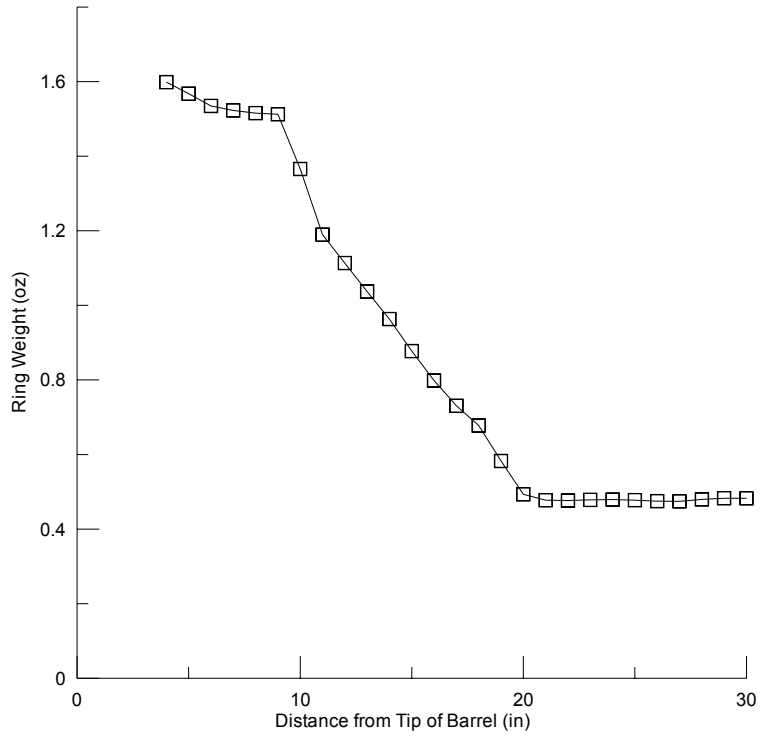
## APPENDIX B



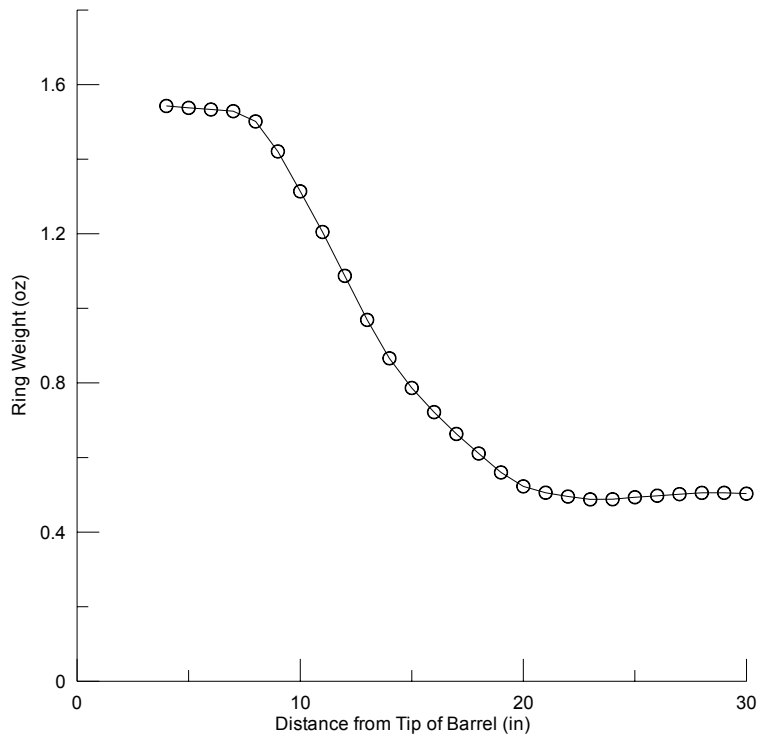
**Ring weight distribution of SN01**



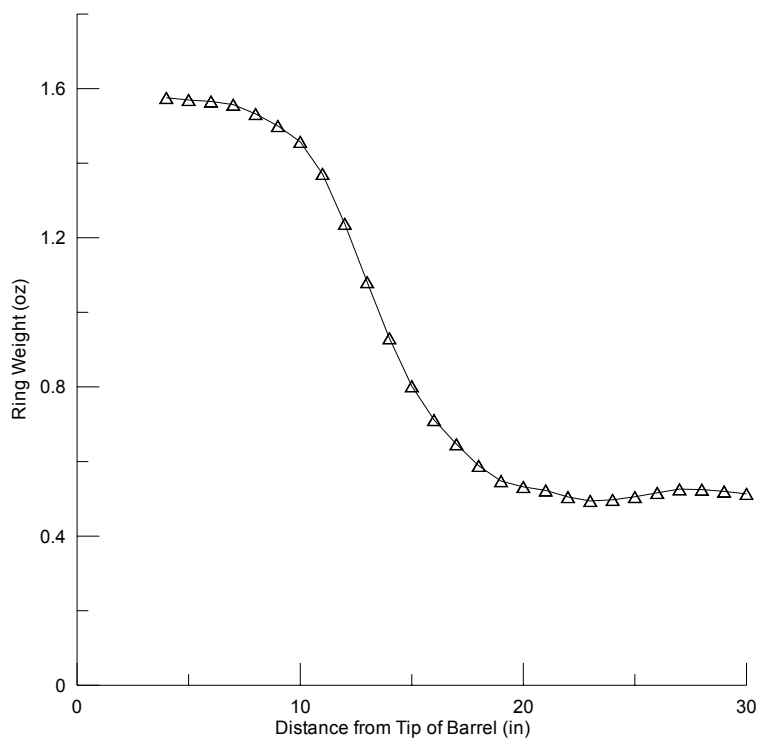
**Ring weight distribution of SN02**



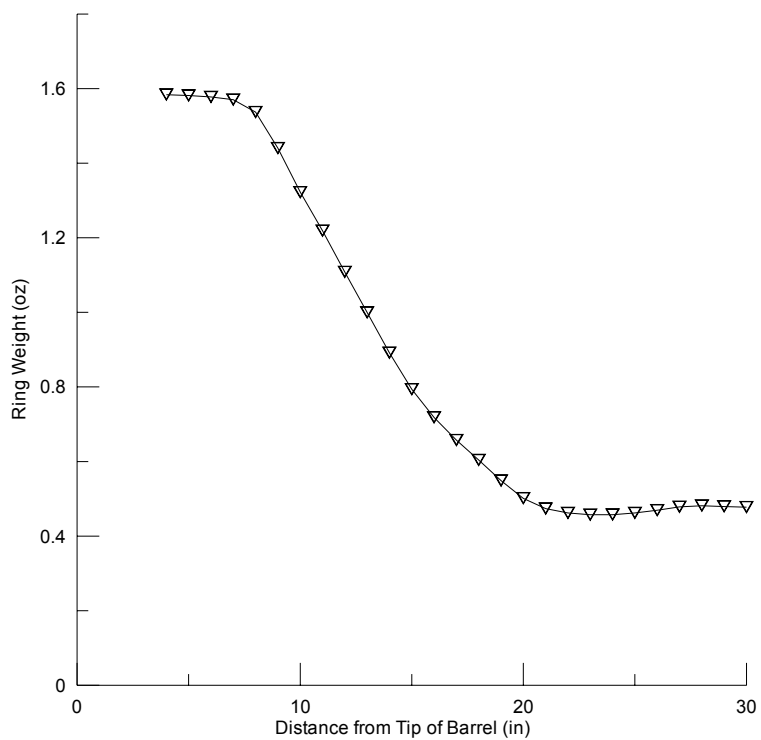
**Ring weight distribution of SN03**



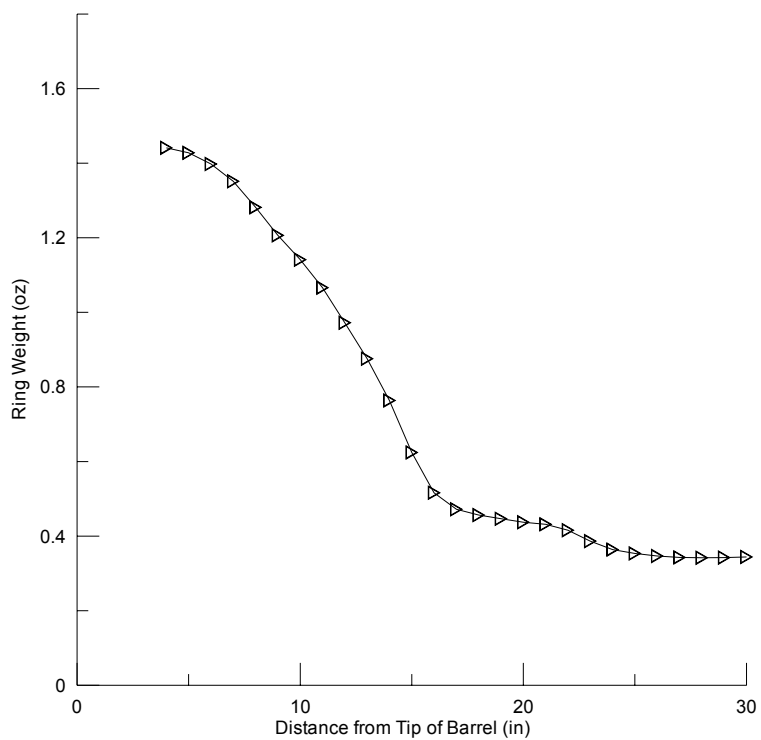
**Ring weight distribution of SN04**



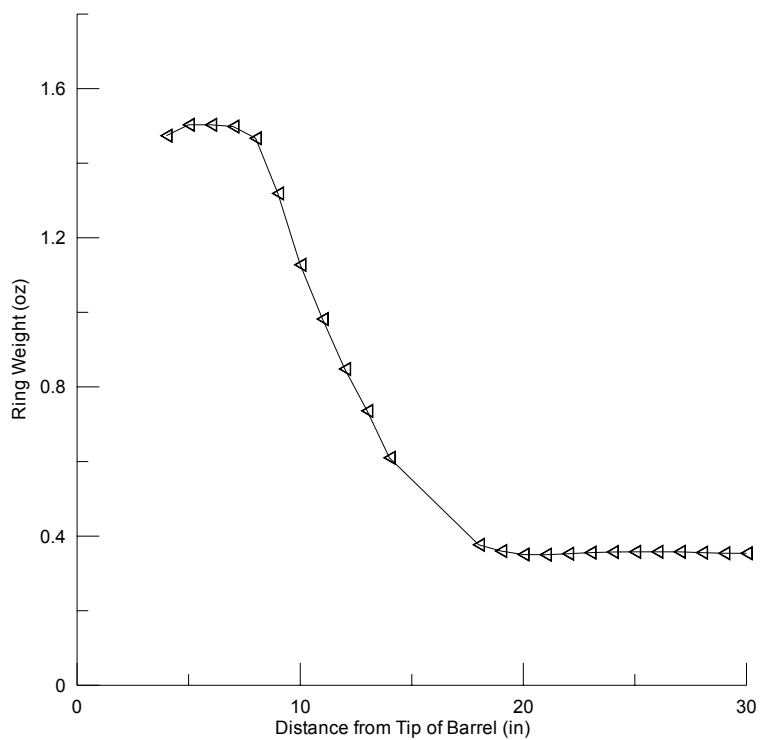
**Ring weight distribution of SN05**



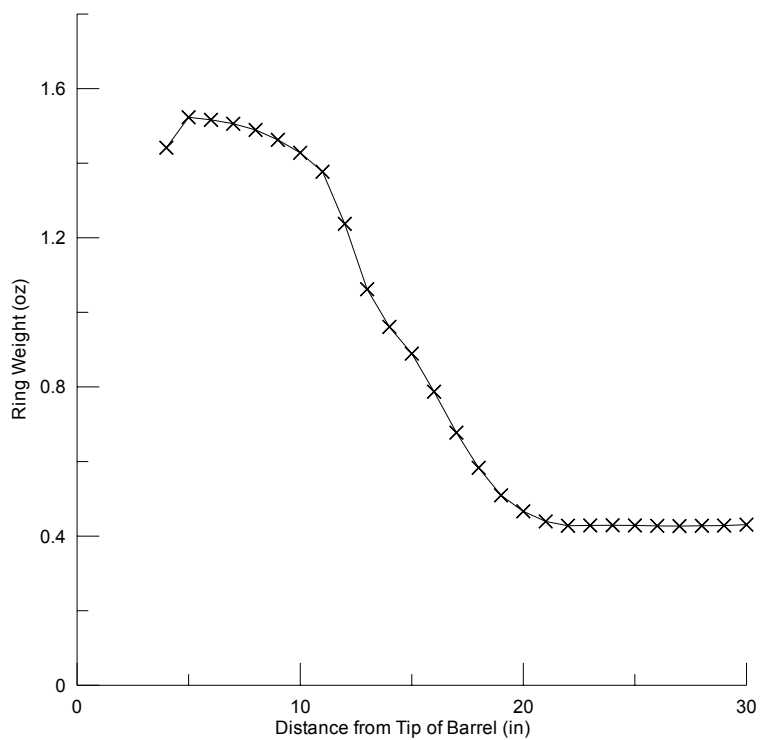
**Ring weight distribution of SN06**



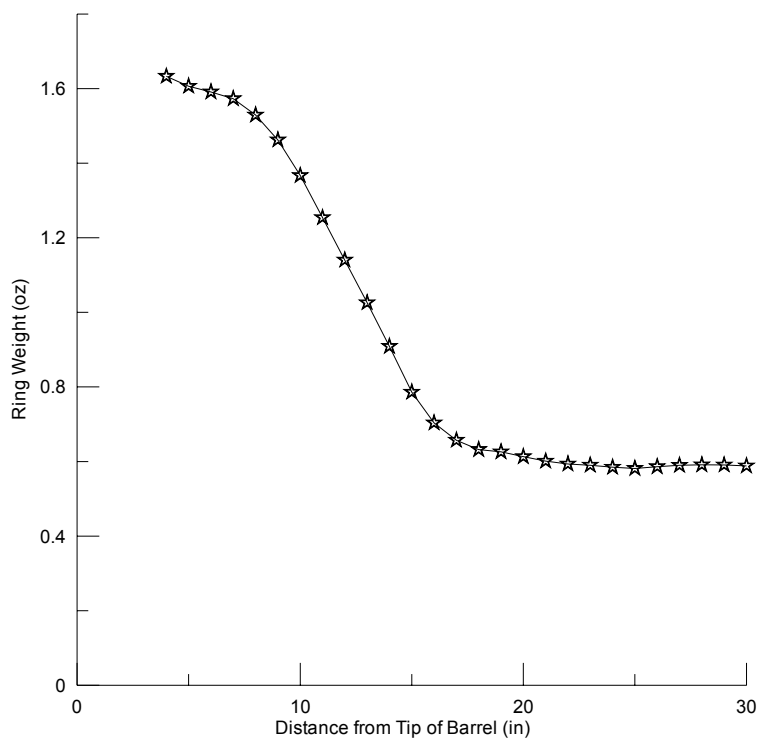
**Ring weight distribution of SN07**



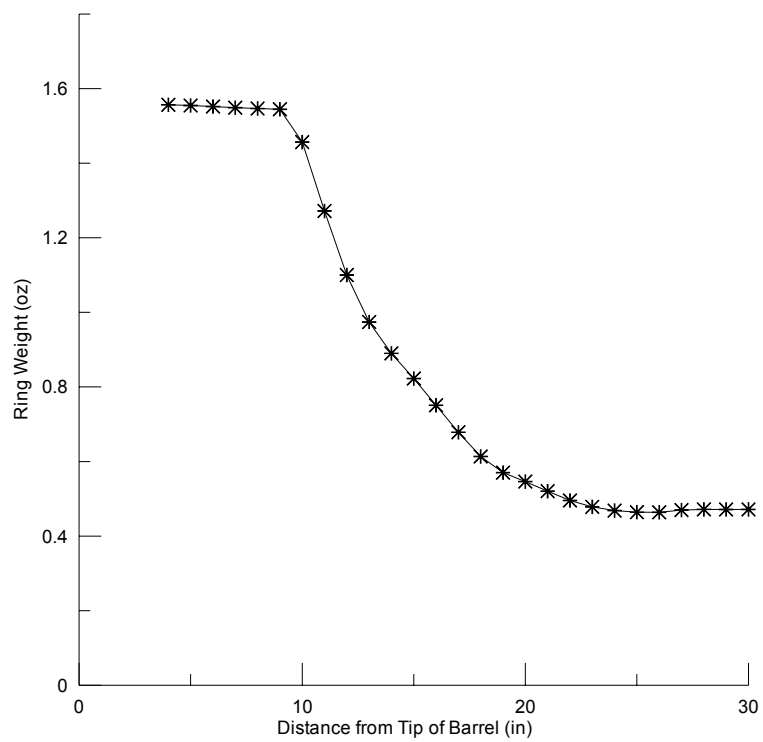
**Ring weight distribution of SN08**



**Ring weight distribution of SN09**

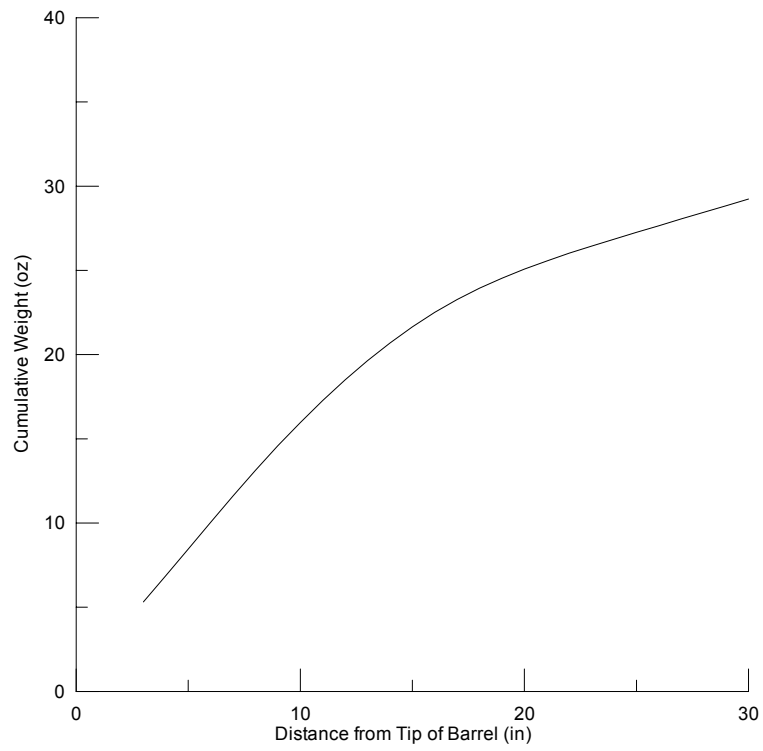


**Ring weight distribution of SN10**

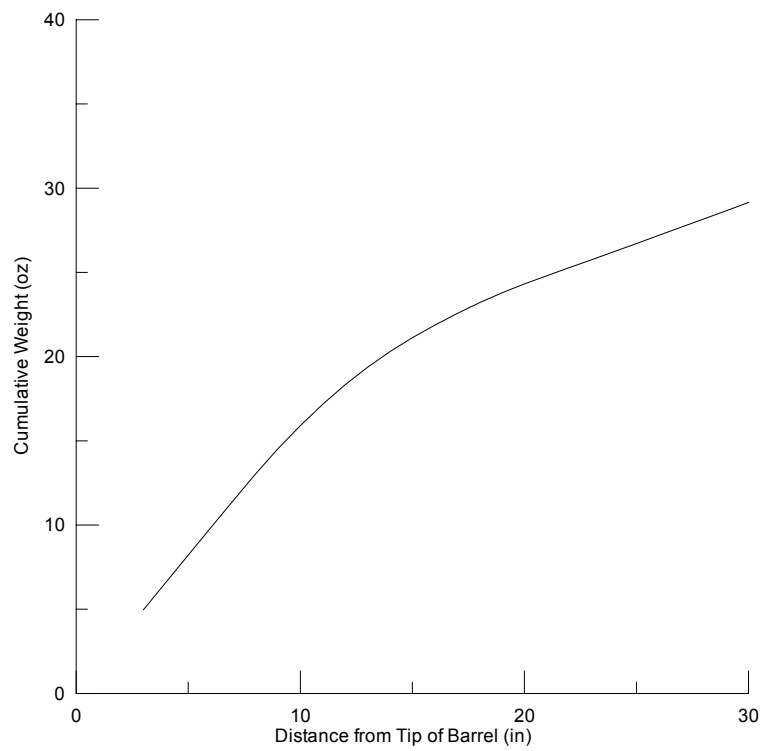


**Ring weight distribution of SN11**

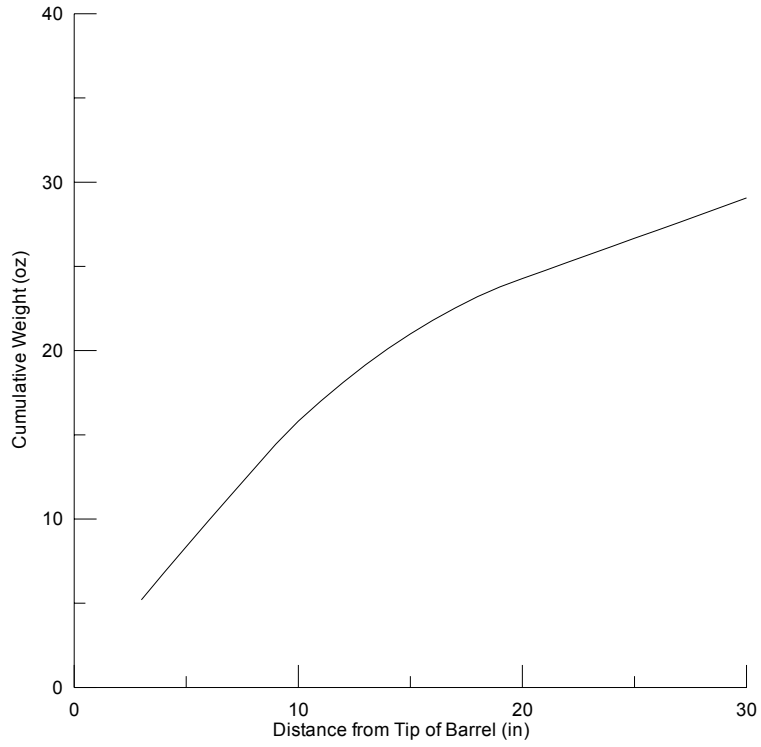
## APPENDIX C



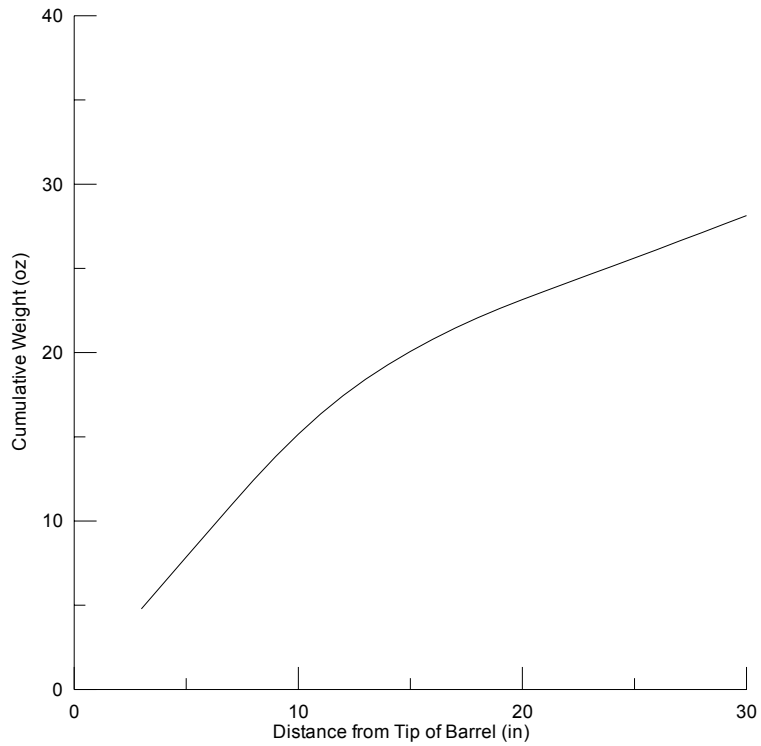
**Cumulative weight distribution of SN01**



**Cumulative weight distribution of SN02**

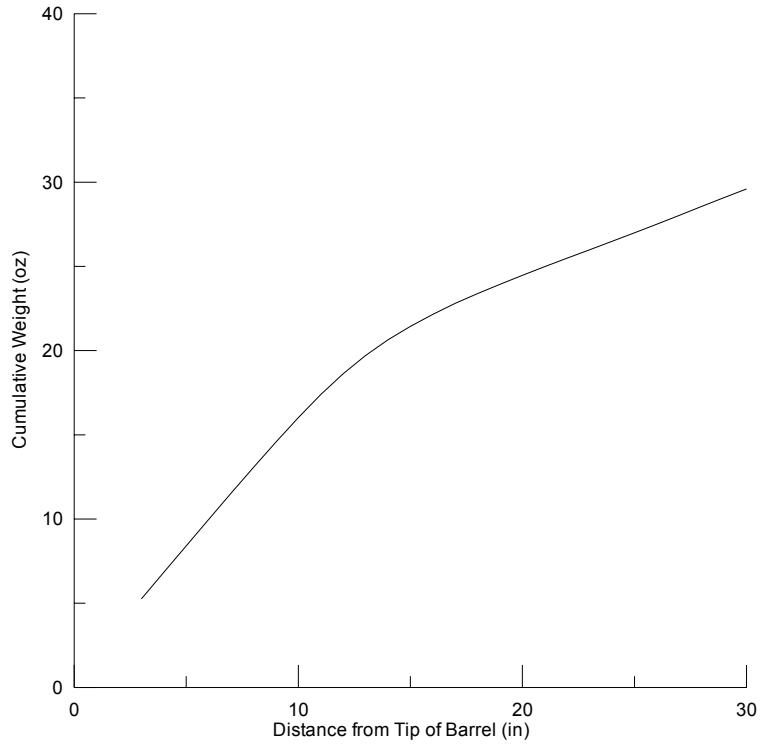


**Cumulative weight distribution of SN03**

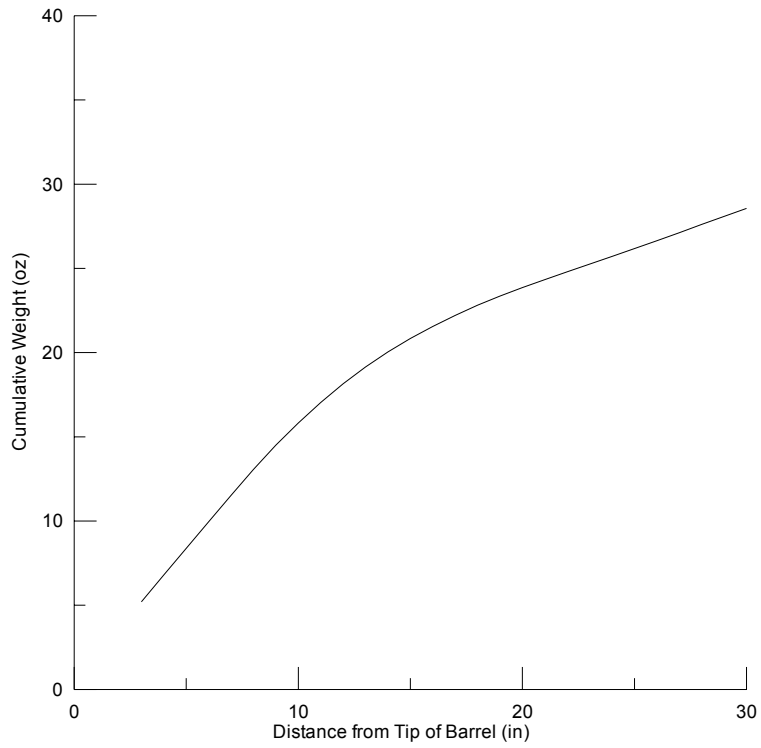


**Cumulative weight distribution of SN04**

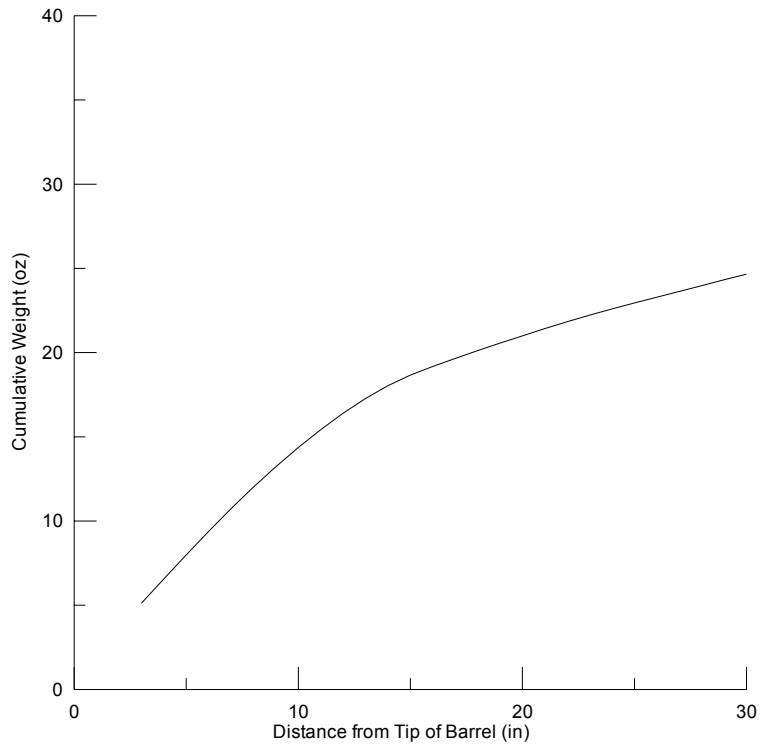




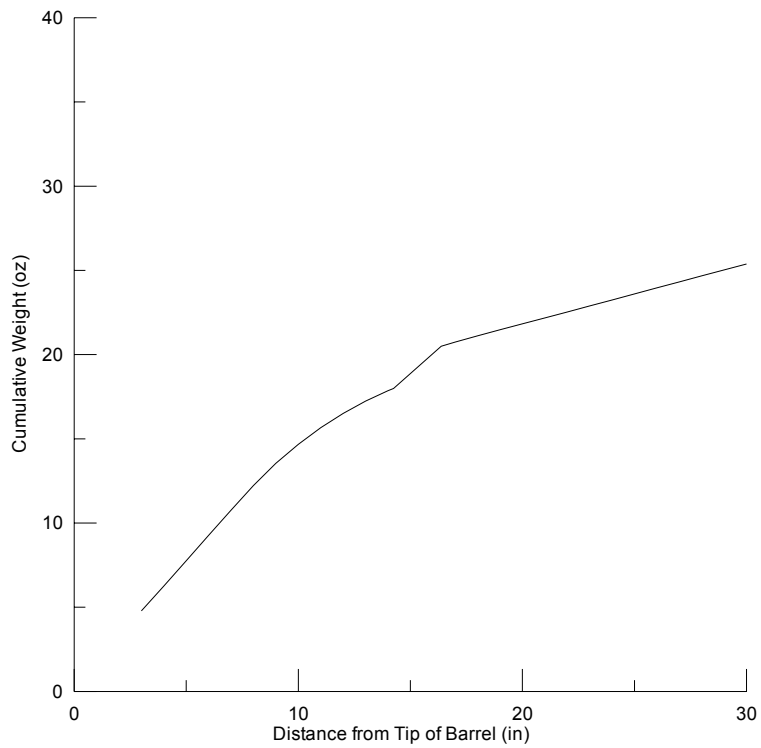
**Cumulative weight distribution of SN05**



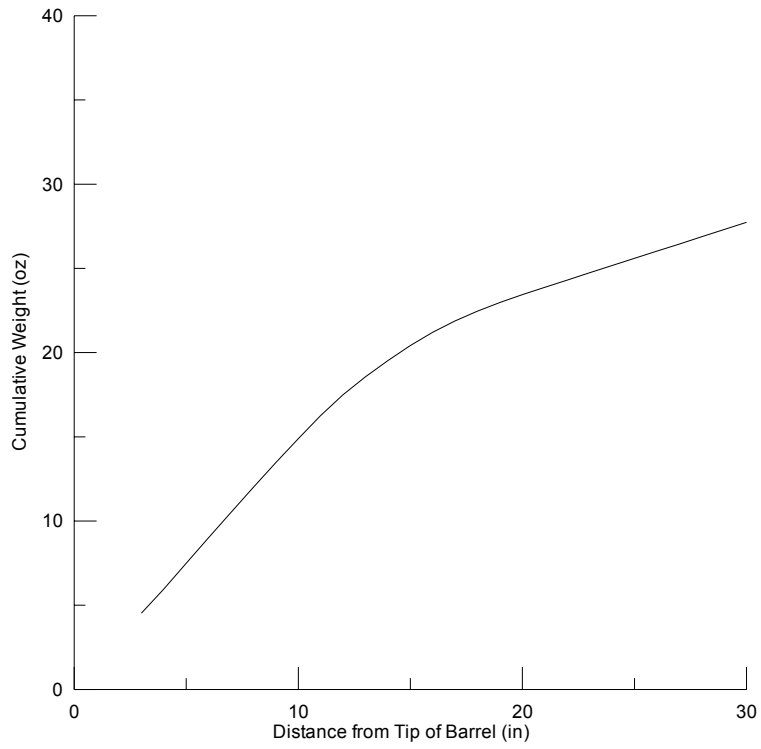
**Cumulative weight distribution of SN06**



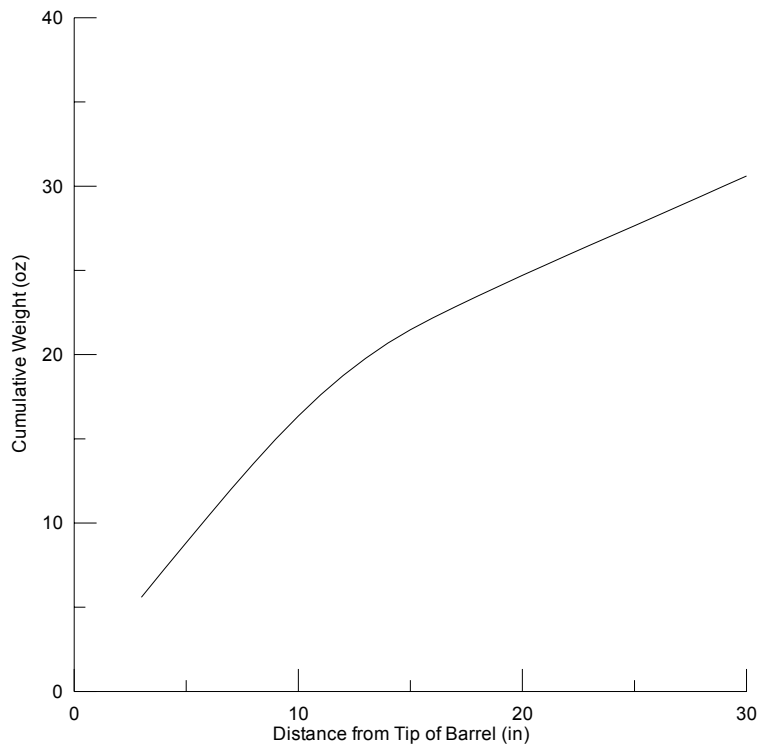
**Cumulative weight distribution of SN07**



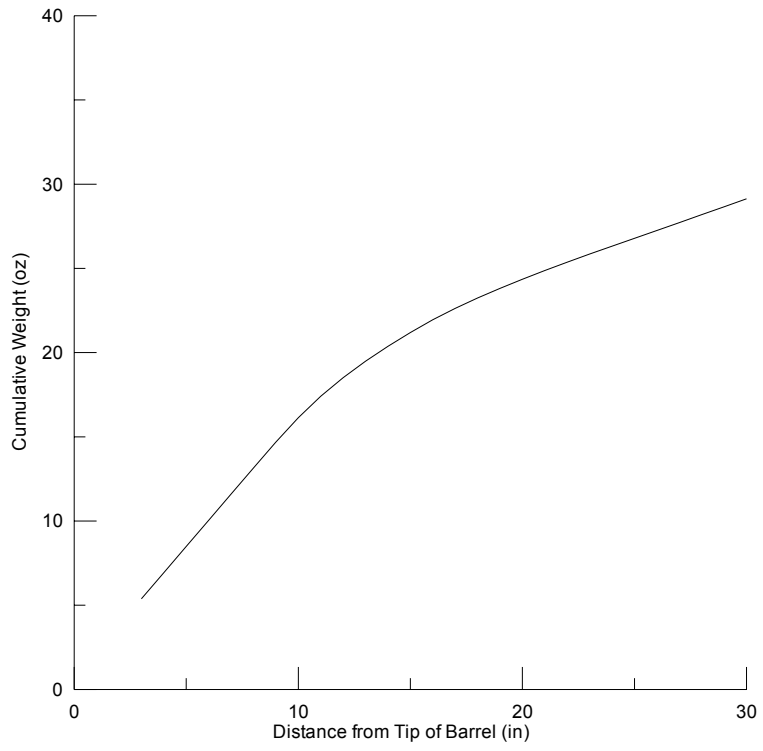
**Cumulative weight distribution of SN08**



**Cumulative weight distribution of SN09**



**Cumulative weight distribution of SN10**



**Cumulative weight distribution of SN11**